



○ Member of GHM GROUP



Light measurement

Light measurement

- HD2102.1, HD2102.2 Portable photo-radiometers	pag. 4
- LP471PYRA Pyranometer	pag. 9
- Radiometric-photometric probes for portable instruments	pag. 10
- HD2302.0 Portable photo-radiometer	pag. 12
- D09721 Portable quantum photo-radiometer and thermometer	pag. 16
- LPPHOT01, LPPAR01, LPRAD01, LPUVA 01, LPUVB01, LPUVC01 Photometric/radiometric probes	pag. 19
- LPPHOT01S Transmitter with RS485 MODBUS-RTU output	pag.21
- LPPHOT03, LPRAD03, LPPAR03, LPUVA03, LPUVB03 Photometric and radiometric probes	pag. 23
- LPPHOT02 Photometric probe	pag. 27
- LPUVA02 Radiometric probe	pag. 30
- LPUVB02 Radiometric probe for environmental use	pag. 33
- HD2021T... Transmitters for illuminance and irradiance measurements	pag. 36
- HD2021T7, HD2021T6 Debilitating luminance probe, luminance probe	pag. 38
- HD2402 Non-coherent optical radiations sensor	pag. 41
- HD30.1 Spectroradiometer	pag. 42
- Laboratories	pag. 45

The qualitative level of our instruments is the result of a continuous evolving of the product itself. This may bring to slight differences between what written in the following manual and the instrument you bought. We cannot completely exclude the presence of errors inside the manual, which we apologise for. Data, images and descriptions included in this manual cannot be enforced legally. We reserve the right to perform modifications and corrections at any time without notice.

HD2102.2, HD2102.2



**HD2102.1 AND HD2102.2
PHOTO-RADIOMETERS**

The **HD2102.1 and HD2102.2** are portable instruments with a large LCD display. They measure **illuminance, luminance, par and irradiance** (across VIS-NIR, UVA, UVB and UVC spectral regions or measurement of irradiance effective according to the UV action curve). The probes are equipped with the SICRAM automatic detection module: in addition to detection, the unit of measurement selection is also automatic. The factory calibration data are already stored inside probes. In addition to instantaneous measurement the instruments calculate the acquired measurements time integral Q(t). Some thresholds can be associated with the integrated measurement and with the integration time, which can be set in the menu. When exceeded, these thresholds cause the instrument to stop the integral calculation. The HD2102.2 instrument is a **datalogger**. It stores up to 38,000 samples with a one-channel probe and up to 14,000 samples with combined probes. These data can be transferred from the instrument to a PC via the connection of the RS232C serial port and USB 2.0. Storing interval, printing and baud rate can be configured by using the menu. The HD2102.1 and HD2102.2 models are equipped with an RS232C serial port and can transfer the acquired measurements in real time to a PC or to a portable printer. The Max, Min and Avg functions calculate the maximum, minimum or average values. Other functions include: the relative measurement REL, the HOLD function and the automatic turning off that can also be excluded. **The instruments have IP66 protection degree.**



HD40.1



SWD10

INSTRUMENT TECHNICAL CHARACTERISTICS

Instrument

Dimensions (Length x Width x Height) 185x90x40mm
Weight 470g (complete with batteries)
Materials ABS, rubber
Display 2x4½ digits plus symbols - 52x42mm
Visible area: 52x42mm

Operating conditions

Operating temperature -5...50°C
Storage temperature -25...65°C
Working relative humidity 0...90%RH without condensation
Protection degree IP66

Power

Batteries 4 1.5V type AA batteries
Autonomy 200 hours with 1800mAh alkaline batteries
Power absorbed with instrument off 20µA
Mains Output mains adapter 12Vdc / 1000mA

Measuring unit

lux - fcd - lux-s - fcd-s - W/m² - µW/cm²
J/m² - µJ/cm² - µmol/(m²s) - µmol/m² - cd/m²
µW/lumen

Security of memorized data

Unlimited, independent of battery charge conditions

Time

Date and time in real time
Accuracy 1min/month max drift

Measured values storage - model HD2102.2

Type (for single probes) 2000 pages containing 19 samples each
Type (for combined probes) 2000 pages containing 7 samples each
Quantity (for single probes) total of 38000 samples
Quantity (for combined probes) total of 14000 samples
Selectable storage interval 1s, 5s, 10s, 15s, 30s, 1min, 2min, 5min, 10min, 15min, 20min, 30min, 1 hour

Serial interface RS232C

Type RS232C electrically isolated
Baud rate Can be set from 1200 to 38400 baud
Data bit 8
Parity None
Stop bit 1
Flow Control Xon/Xoff
Serial cable length Max 15m
Selectable printing interval Immediate or 1s, 5s, 10s, 15s, 30s, 1min, 2min, 5min, 10min, 15min, 20min, 30min, 1 hour

USB interface - model HD2102.2

Type 1.1 - 2.0 electrically isolated

Connections

Input module for the probes 8-pole male DIN45326 connector
RS232 serial interface 8-pole MiniDin connector
USB serial interface B-type MiniUSB connector
Mains adapter 2-pole connector (positive at centre)

Technical characteristics of photometric and radiometric probes equipped with SICRAM module for the connection to the instrument

LP471PHOT probe for the measure of ILLUMINANCE				
Measuring range (lux):	0.10...199.99	...1999.9	...19999	...199.99·10 ³
Resolution (lux):	0.01	0.1	1	0.01·10 ³
Spectral range:	in agreement with standard photopic curve V(λ)			
Class	B			
Calibration uncertainty:	<4%			
f ₁ (in agreement with photopic response V(λ)):	<6%			
f ₂ (response according to the cosine law):	<3%			
f ₃ (linearity):	<1%			
f ₄ (instrument reading error):	<0.5%			
f ₅ (fatigue):	<0.5%			
α (temp. coefficient) f ₅ (T)	<0.05%K			
Drift after 1 year:	<1%			
Working temperature:	0...50°C			
Reference Standards	CIE n.69 - UNI 11142			

Photometric probe for **ILLUMINANCE** measurement, spectral response in agreement with standard photopic vision, diffuser for cosine correction. Measurement range: 0.10 lux...200·10³ lux.



LP471LUM2 probe for the measure of LUMINANCE				
Measuring range (cd/m ²):	1.0...1999.9	...19999	...199.99·10 ³	...1999.9·10 ³
Resolution (cd/m ²):	0.1	1	0.01·10 ³	0.1·10 ³
Optical angle:	2°			
Spectral range:	in agreement with standard photopic curve V(λ)			
Class	C			
Calibration uncertainty:	<5%			
f ₁ (in agreement with photopic response V(λ)):	<8%			
f ₃ (linearity):	<1%			
f ₄ (instrument reading error):	<0.5%			
f ₅ (fatigue):	<0.5%			
α (temp. coefficient) f ₆ (T)	<0.05%K			
Drift after 1 year:	<1%			
Working temperature:	0...50°C			
Reference Standards	CIE n.69 - UNI 11142			

Photometric probe for **LUMINANCE** measurement, spectral response in agreement with standard photopic vision, vision angle 2°. Measurement range: 1.0 cd/m²...2000·10³ cd/m².

Typical response curve: LP471PHOT and LP471LUM2

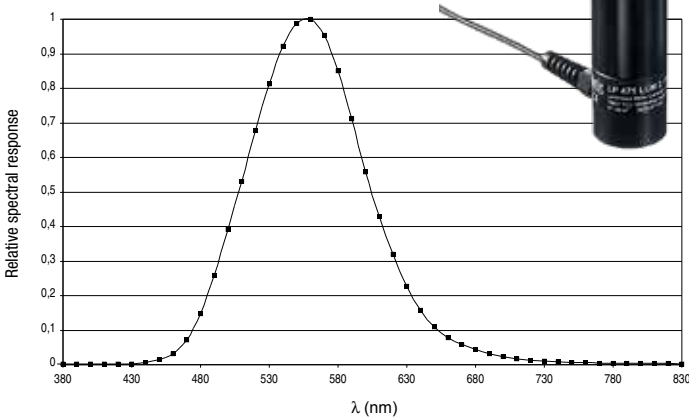

LP471RAD probe for the measure of IRRADIANCE				
Measuring range (W/m ²):	1.0·10 ⁻³ ...999.9·10 ⁻³	1.000...19.999	20.00...199.99	200.0...1999.9
Resolution (W/m ²):	0.1·10 ⁻³	0.001	0.01	0.1
Spectral range:	400nm...1050nm			
Calibration uncertainty:	<5%			
f ₂ (response according to the cosine law):	<6%			
f ₃ (linearity):	<1%			
f ₄ (instrument reading error):	±1 digit			
f ₅ (fatigue):	<0.5%			
Drift after 1 year:	<1%			
Working temperature:	0...50°C			

Radiometric probe for **IRRADIANCE** measurement in the spectral range 400nm...1050nm, diffuser for cosine correction. Measurement range: 1.0·10⁻³W/m²...2000W/m².

Typical response curve: LP471RAD

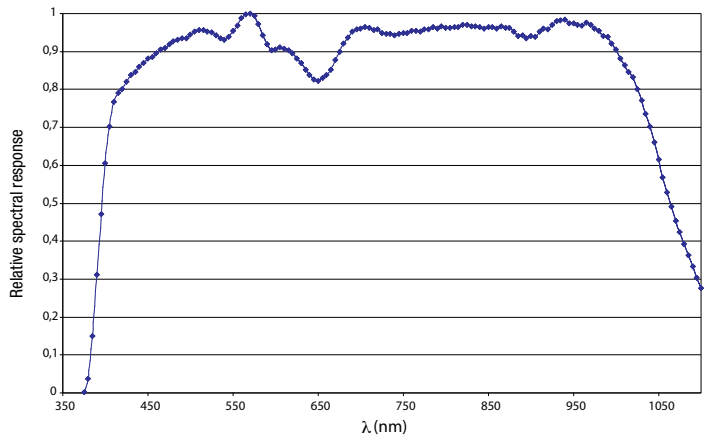

LP471PAR quantum radiometric probe for the measure of the photon flow across the chlorophyll range PAR			
Measuring range (μmol·m ⁻² ·s ⁻¹):	0.10...199.99	200.0...1999.9	2000...10000
Resolution (μmol·m ⁻² ·s ⁻¹):	0.01	0.1	1
Spectral range:	400nm...700nm		
Calibration uncertainty:	<5%		
f ₂ (response according to the cosine law):	<6%		
f ₃ (linearity):	<1%		
f ₄ (instrument reading error):	±1 digit		
f ₅ (fatigue):	<0.5%		
Drift after 1 year:	<1%		
Working temperature:	0...50°C		

Quantum radiometric probe for the measurement of the photon flow across the chlorophyll range **PAR** (Photosynthetically Active Radiation 400nm...700nm), measurement in μmol/m²·s. Measurement range: 0.10 μmol·m⁻²·s⁻¹...10·10³ μmol·m⁻²·s⁻¹.

Typical response curve: LP471PAR

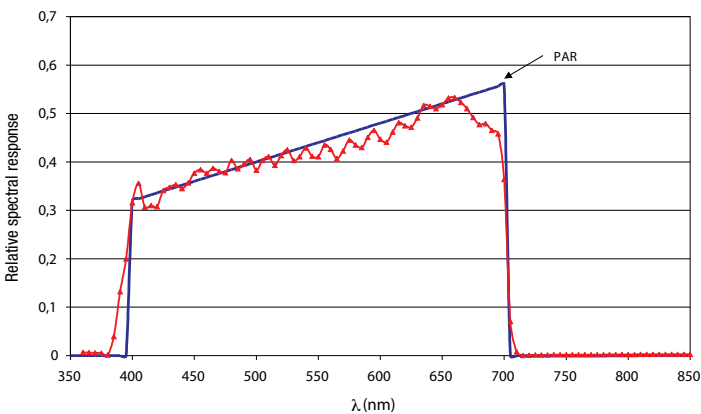

LP471UVA probe for the measure of UVA IRRADIANCE				
Measuring range (W/m ²):	1.0·10 ⁻³ ...999.9·10 ⁻³	1.000...19.999	20.00...199.99	200.0...1999.9
Resolution (W/m ²):	0.1·10 ⁻³	0.001	0.01	0.1
Spectral range:	315nm...400nm (Peak 360nm)			
Calibration uncertainty:	<5%			
f ₃ (linearity):	<1%			
f ₄ (instrument reading error):	±1 digit			
f ₅ (fatigue):	<0.5%			
Drift after 1 year:	<2%			
Working temperature:	0...50°C			

Radiometric probe for **IRRADIANCE** measurement, in the 315nm...400nm, peak 360nm, **UVA** spectral range. Measurement range: 1.0·10⁻³W/m²...2000W/m².

Typical response curve: LP471UVA

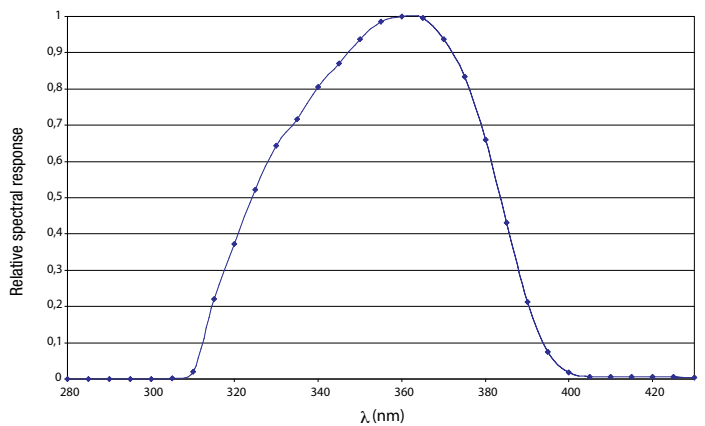

LP471UVB probe for the measure of UVB IRRADIANCE				
Measuring range (W/m ²):	1.0·10 ⁻³ ...999.9·10 ⁻³	1.000...19.999	20.00...199.99	200.0...1999.9
Resolution (W/m ²):	0.1·10 ⁻³	0.001	0.01	0.1
Spectral range:	280nm...315nm (Peak 305nm...310nm)			
Calibration uncertainty:	<5%			
f ₃ (linearity):	<2%			
f ₄ (instrument reading error):	±1 digit			
f ₅ (fatigue):	<0.5%			
Drift after 1 year:	<2%			
Working temperature:	0...50°C			

Radiometric probe for **IRRADIANCE** measurement, in the spectral range 280nm...315nm, peak 305nm ... 310nm, Measurement range: 1.0·10⁻³W/m²...2000W/m².



Typical response curve: LP471UVB

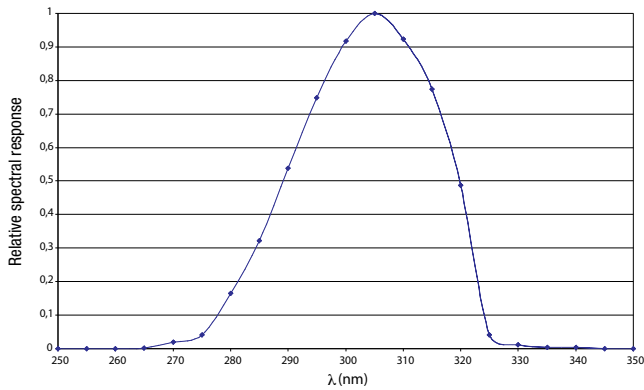

LP471UVC probe for the measure of UVC IRRADIANCE				
Measuring range (W/m ²):	1.0·10 ⁻³ ...999.9·10 ⁻³	1.000...19.999	20.00...199.99	200.0...1999.9
Resolution (W/m ²):	0.1·10 ⁻³	0.001	0.01	0.1
Spectral range:	220nm...280nm (Peak 260nm)			
Calibration uncertainty:	<5%			
f ₃ (linearity):	<1%			
f ₄ (instrument reading error):	±1 digit			
f ₅ (fatigue):	<0.5%			
Drift after 1 year:	<2%			
Working temperature:	0...50°C			

Radiometric probe for **IRRADIANCE** measurement, in the spectral range 220nm...280nm, peak 260nm, **UVC**. Measurement range: 1.0·10⁻³W/m²...2000W/m².



Typical response curve: LP471UVC

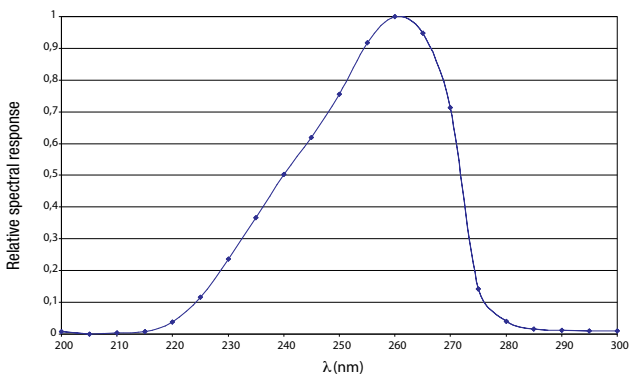

Combined probe LP471P-A with two sensors for the measure of ILLUMINANCE and UVA IRRADIANCE				
<i>Illuminance</i>				
Measuring range (lux):	0.3...199.9	...1999.9	...19999	...199.99·10 ³
Resolution (lux):	0.01	0.1	1	0.01·10 ³
Spectral range:	in agreement with standard photopic curve V(λ)			
α (temp. coefficient) f ₆ (T)	<0.05%K			
Calibration uncertainty:	<4%			
f ₁ (in agreement with photopic response V(λ)):	<6%			
f ₂ (response according to the cosine law):	<3%			
f ₃ (linearity):	<1%			
f ₄ (instrument reading error):	<0.5%			
f ₅ (fatigue):	<0.5%			
Class:	B			
Drift after 1 year:	<1%			
Working temperature:	0...50°C			
Reference Standards	CIE n.69 - UNI 11142			

Please refer to the spectral response of the LP471PHOT probe

<i>UVA Irradiance</i>				
Measuring range (μW/cm ²):	0.10...199.99	...1999.9	...19999	...199.99·10 ³
Resolution (μW/cm ²):	0.01	0.1	1	0.01·10 ³
Spectral range:	315nm...400nm (Peak 360nm)			
Calibration uncertainty:	<5%			
f ₂ (response according to the cosine law):	<6%			
f ₃ (linearity):	<1%			
f ₄ (instrument reading error):	±1 digit			
f ₅ (fatigue):	<0.5%			
Drift after 1 year:	<2%			
Working temperature:	0...50°C			

Please refer to the spectral response of the LP471UVA probe



LPSILICON-PYRA probe for the measure of GLOBAL SOLAR RADIATION				
Measurement range (W/m ²):	1.0·10 ⁻³ ... 999.9·10 ⁻³	1.000...19.999	20.00...199.99	200.0...1999.9
Resolution (W/m ²):	0.1·10 ⁻³	0.001	.01	0.01
Spectral range:	400 nm ... 1100 nm			
Calibration uncertainty:	<3%			
f ₂ (response according to the cosine law):	<3%			
f ₃ (linearity):	<1%			
f ₄ (instrument reading error):	±1 digit			
f ₅ (fatigue):	<0.5%			
Drift after 1 year:	<2%			
Working temperature:	0...50°C			

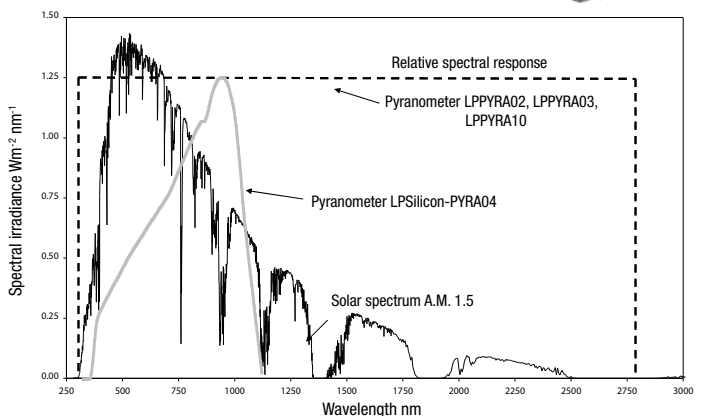

LP471A-UVeff probe for the measure of TOTAL EFFECTIVE IRRADIANCE weighted according to the UV action curve (CEI EN 60335-2-27)	
Total Effective Irradiance	
Measuring range (W_{eff}/m^2):	0.010 ... 19.999
Resolution (W_{eff}/m^2):	0.001
Spectral range:	UV action curve for measuring erythema (250 nm...400 nm)
Calibration uncertainty:	<15%
f_3 (linearity):	<3%
f_4 (instrument reading error):	± 1 digit
f_5 (fatigue):	<0.5%
Drift after 1 year:	<2%
Working temperature:	0...50°C
UV Irradiance	
Measuring range (W_{eff}/m^2):	0.1 ... 1999.9
Resolution (W_{eff}/m^2):	0.1
Spectral range:	315 nm ... 400 nm
UV_BC Irradiance	
Measuring range (W_{eff}/m^2):	0.010 ... 19.999
Resolution (W_{eff}/m^2):	0.001
Spectral range:	250 nm ... 315 nm

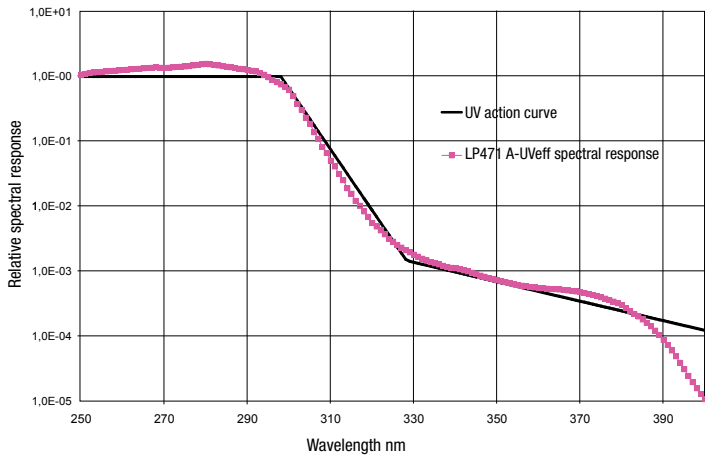

LP471BLUE probe for the measure of IRRADIANCE in spectral band of BLUE LIGHT				
Measurement range (W/m^2):	1.0·10 ⁻³ ... 999.9·10 ⁻³	1.000...19.999	20.00...199.99	200.0...1999.9
Resolution (W/m^2):	0.1·10 ⁻³	0.001	.01	0.01
Spectral range:	380 nm ... 550 nm. Action curve for damages of Blue light B(λ)			
Calibration uncertainty:	<10%			
f_2 (response according to the cosine law):	<6%			
f_3 (linearity):	<3%			
f_4 (instrument reading error):	± 1 digit			
f_5 (fatigue):	<0.5%			
Drift after 1 year:	<2%			
Working temperature:	0...50°C			

Relative spectral response

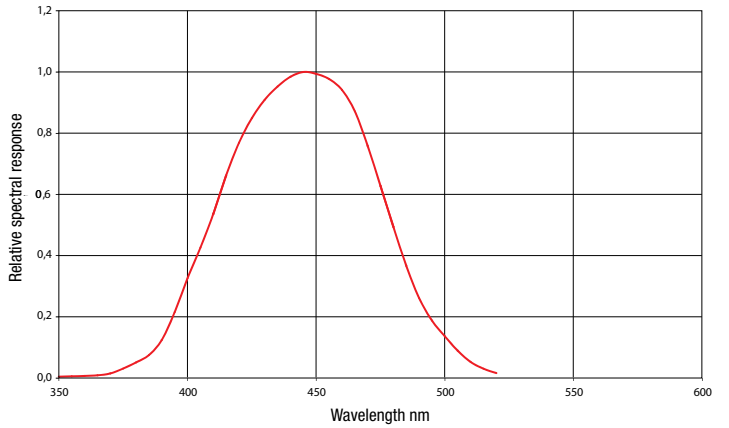

The radiometric probe LP471-BLUE measures irradiance (W/m^2) in spectral band of blue light. The probe consists of a photodiode plus an appropriate filter and it is provided with diffuser for proper measure in accordance with the cosine law. The spectral response curve of the probe allows to measure the radiation effective for damages caused by blue light (curve B(λ)) according to the standards ACGIH / ICNIRP in the spectral range from 380nm to 550nm. The radiation optics in this portion of the spectrum can produce photochemical damage to the retina. Another field of application is the monitoring of the probe irradiance from blue light used in the treatment of neonatal jaundice.



ORDERING CODES:

- HD2102.1:** The kit consists of the instrument HD2102.1, 4 1.5V alkaline batteries, operating manual, case and DeltaLog9 software downloadable from Delta OHM website. **Probes and cable must be ordered separately.**
- HD2102.2:** The kit consists of the HD2102.2 datalogger, 4 1.5V alkaline batteries, operating manual, case and DeltaLog9 software downloadable from Delta OHM website, USB cable CP23. **Probes and cable must be ordered separately.**
- HD2110CSNM:** 8-pole connection cable MiniDin - Sub D 9-pole female for RS232C.
- C.206:** Cable for the connection of the instrument HD21...1 to the PC USB ports directly.
- SWD10:** Stabilized power supply at 230Vac/12Vdc-1000mA mains voltage.
- HD40.1:** Portable, serial input, 24 column thermal printer, 58mm paper width.

Probes complete with SICRAM module

- LP471PHOT:** Photometric probe for measuring **ILLUMINANCE** complete with SICRAM module, spectral response in agreement with standard photopic vision, Class B according to CIE n°69, diffuser for cosine correction. Measurement range: 0.10 lux...200·10³ lux.
- LP471LUM2:** Photometric probe for measuring **LUMINANCE** complete with SICRAM module, spectral response in agreement with standard photopic vision, vision angle 2°. Measurement range: 1.0 cd/m²...2000·10³ cd/m².
- LP471PAR:** Quantum radiometric probe for the measurement of the photon flow across the chlorophyll range **PAR** (Photosynthetically Active Radiation 400nm...700nm) complete with SICRAM, measurement in $\mu\text{mol}\cdot\text{m}^{-2}\cdot\text{s}^{-1}$, diffuser for cosine correction. Measurement range: 0.10 $\mu\text{mol}\cdot\text{m}^{-2}\cdot\text{s}^{-1}$...10·10³ $\mu\text{mol}\cdot\text{m}^{-2}\cdot\text{s}^{-1}$.
- LP471RAD:** Radiometric probe for measuring **IRRADIANCE** equipped with SICRAM module; in the 400nm...1050nm spectral range, diffuser for cosine correction. Measurement range: 1.0·10⁻³W/m²...2000W/m².
- LP471UVA:** Radiometric probe for measuring **IRRADIANCE** equipped with SICRAM module; in the 315nm...400nm, peak 360nm, **UVA** spectral range, quartz diffuser for cosine correction. Measurement range: 1.0·10⁻³W/m²...2000 W/m².
- LP471UVB:** Radiometric probe for measuring **IRRADIANCE** equipped with SICRAM module, in the 280nm...315nm, peak 305nm ... 310nm, **UVB** spectral range, quartz diffuser for cosine correction. Measurement range: 1.0·10⁻³W/m²...2000 W/m².
- LP471UVC:** Radiometric probe for measuring **IRRADIANCE** equipped with SICRAM module, in the 220nm...280nm, peak 260nm, **UVC** spectral range, quartz diffuser for cosine correction. Measurement range: 1.0·10⁻³W/m²...2000 W/m².
- LP471BLUE:** Radiometric probe for measuring **IRRADIANCE** (W/m²) in spectral band of blue light equipped with SICRAM module. Spectral range: 380 nm...550 nm, quartz diffuser for cosine correction. Measurement range: 1.0·10⁻³W/m²... 2000 W/m².
- LP471P-A:** Combined probe for measuring **ILLUMINANCE** (lux), with standard photopic response, and **IRRADIANCE** ($\mu\text{W}/\text{cm}^2$) in the UVA spectral range (315...400 nm, with peak at 360 nm). Both the sensors are equipped with diffuser for the correction according to the cosine law.
Illuminance measuring range: 0.3 lux ... 200·10³ lux
Irradiance measuring range: 1.0 mW/m² ... 2000 W/m².
This probe provides the ratio between UVA irradiance and illuminance in $\mu\text{W}/\text{lumen}$ (quantity of interest in museums). The probe is equipped with SICRAM module and cable 2m long.
- LP471A-Uveff:** Combined probe for measuring the **TOTAL EFFECTIVE IRRADIANCE** (W/m²) weighted according to the UV action curve. The probe is made of two sensors for the correct measure of the Total Effective Irradiance in the range 250...400nm. Both these sensors are equipped with a diffuser for the correction according to the cosine law.
This probe supplies the Total effective irradiance (Eeff), the UV-CB effective irradiance and the UVA Irradiance.
Total effective irradiance measuring range: 0.010 W/m² ... 20 W/m².
B_C effective irradiance measuring range: 0.010 W/m² ... 20 W/m².
UVA irradiance measuring range: 0.1 W/m² ... 2000 W/m².
The probe is equipped with the SICRAM module and a cable 2m long.
- LP471PYRA02..., LP471PYRA03..., LP471PYRA10..., LP471Silicon-PYRA...**
- LPBL:** Base with levelling device for all the above-described probes except for the probes LP471LUM 2 and LP471PYRA.
- LPBL3:** Jointed support for all the above-described probes except for LP471LUM2 and LP471PYRA.

- A** The models of portable data logger series HD21xx.2 has been implemented with a serial port miniUSB type HID (Human Interface Device).
When making the connection to the PC by the USB cable type A - Mini USB B-type coded CP23, **no USB driver installation is requested.**
- B** For the connection of the models **HD21xx.1** to the RS232 port of your PC, the USB/serial converter is available (code **C.206**). The converter is equipped with its own drivers that have to be installed before connecting the converter to the PC.
- C** The port with the MiniDIN connector which is present on every model is an RS232C type. By means of the cable coded HD2110CSNM, an RS232 port of a PC or the HD40.1 printer can be connected.

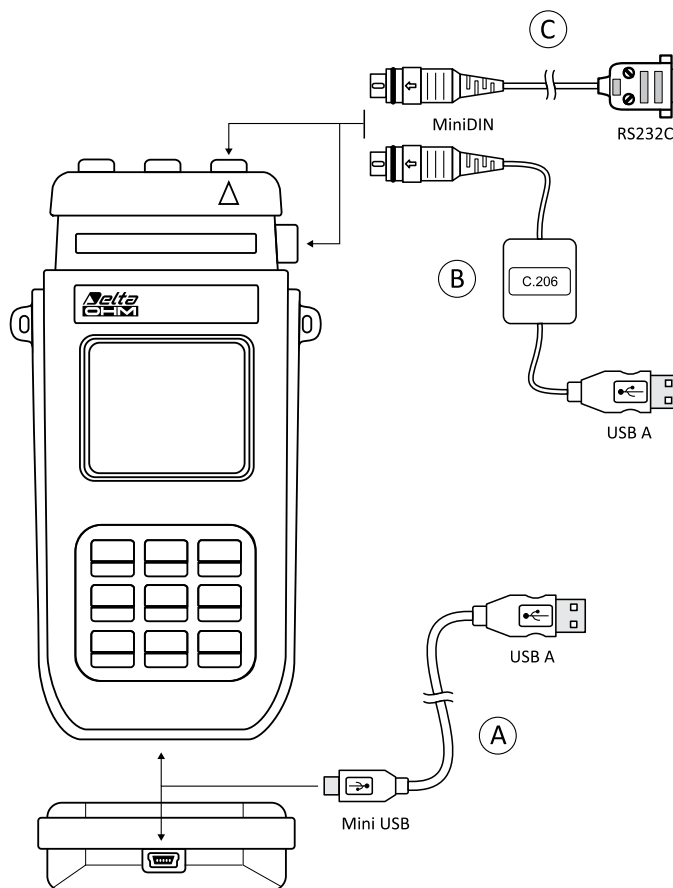

LP471PYRA02, LP471PYRA03, LP471PYRA10,
LP471Silicon-PYRA



PROBES LP471PYRA02.5 / LP471PYRA02.10 - LP471PYRA03.5 / LP471PYRA03.10 - LP471PYRA10.5 / LP471PYRA10.10 - LP471SILICON-PYRA

The LP471PYRA... probes consist of a pyranometer LPPYRA03, LPPYRA02 or LPPYRA10 equipped with the SICRAM module and a 5m or 10m cable for the connection of the pyranometer to the instruments HD31, D09847, HD2102.2, HD2102.1 and HD2302.0, so to get the reading in W/m² directly on the instrument's display.

The LPPYRA03 is a second class pyranometer, the LPPYRA02 is a first class pyranometer and the LPPYRA10 is a "Secondary standard", all according to ISO 9060. The instruments are supplied with their Calibration Report and M12 4-pole output

connector. The manuals of the pyranometers LPPYRA03, LPPYRA02 and LPPYRA10 are available in our website www.deltaohm.com: "Instruments > Environmental Analysis".

The SICRAM module of the LP471PYRA... shows the same serial number of the pyranometer and its setting takes into account the sensitivity shown on the calibration report of the pyranometer, therefore it is not possible to use the same module to perform measurements with different pyranometers.

ORDERING CODES:

LP471PYRA10.5: The probe consists of a Secondary Standard class pyranometer LPPYRA10 with a cable 5m long and the SICRAM module. It is supplied with the ISO 9001 calibration report of the pyranometer connected to the cable and the SICRAM module. The probe can be connected to the instruments HD2302.0, HD2102.1, HD2102.2, D09847 and HD31.

For technical specs, see the website www.deltaohm.com at the section Environmental Analysis (LPPYRA10)

LP471PYRA10.10: The probe consists of a Secondary Standard class pyranometer LPPYRA10 with a cable 10m long and the SICRAM module. It is supplied with the ISO 9001 calibration report of the pyranometer connected to the cable and the SICRAM module. The probe can be connected to the instruments HD2302.0, HD2102.1, HD2102.2, D09847 and HD31.

For technical specs, see the website www.deltaohm.com at the section Environmental Analysis (LPPYRA10)

LP471PYRA02.5: The probe consists of a first class pyranometer LPPYRA02 with a cable 5m long and the SICRAM module. It is supplied with the ISO 9001 calibration report of the pyranometer connected to the cable and the SICRAM module. The probe can be connected to the instruments HD2302.0, HD2102.1, HD2102.2, D09847 and HD31.

For technical specs, see the website www.deltaohm.com at the section Environmental Analysis (LPPYRA02)

LP471PYRA02.10: The probe consists of a first class pyranometer LPPYRA02 with a cable 10m long and the SICRAM module. It is supplied with the ISO 9001 calibration report of the pyranometer connected to the cable and the SICRAM module. The probe can be connected to the instruments HD2302.0, HD2102.1, HD2102.2, D09847 and HD31.

For technical specs, see the website www.deltaohm.com at the section Environmental Analysis (LPPYRA02)

LP471PYRA03.5: The probe consists of a second class pyranometer LPPYRA03 with a cable 5m long and the SICRAM module. It is supplied with the ISO 9001 calibration report of the pyranometer connected to the cable and the SICRAM module. The probe can be connected to the instruments HD2302.0, HD2102.1, HD2102.2, D09847 and HD31.

For technical specs, see the website www.deltaohm.com at the section Environmental Analysis (LPPYRA03)

LP471PYRA03.10: The probe consists of a second class pyranometer LPPYRA03 with a cable 10m long and the SICRAM module. It is supplied with the ISO 9001 calibration report of the pyranometer connected to the cable and the SICRAM module. The probe can be connected to the instruments HD2302.0, HD2102.1, HD2102.2, D09847 and HD31.

For technical specs, see the website www.deltaohm.com at the section Environmental Analysis (LPPYRA03)

LP471Silicon-PYRA: Pyranometer with silicon photodiode with 5m fixed cable and open wires at the cable end. The probe can be connected to the instruments HD2302.0, HD2102.1, HD2102.2, D09847 and HD31.











LP471PYRA03.5









LP471PYRA02.5
LP471PYRA10.5

RADIOMETRIC-PHOTOMETRIC PROBES FOR PORTABLE INSTRUMENTS

COD.	Description	
LP471PHOT	Photometric probe for measuring the ILLUMINANCE , spectral response according to the photopic curve, class B according to CIE N° 69 , cosine correction diffuser. Measuring range: 0.10 lux...200·10 ³ lux.	
LP471LUM2	Photometric probe for measuring the LUMINANCE , spectral response according to the photopic curve, angular field 2°. Measuring range: 1.0 cd/m ² ...2000·10 ³ cd/m ² .	
LP471PAR	Quantum-radiometric probe for measuring the PHOTONS FLOW in the chlorophyll field PAR (photosynthetically Active Radiation 400nm...700 nm), μmol m ⁻² s ⁻¹ measure, cosine correction diffuser. Measuring range 0.10 μmol m ⁻² s ⁻¹ ...10·10 ³ μmol m ⁻² s ⁻¹	
LP471PAR02	Quantum-radiometric probe for measuring the PHOTONS FLOW in the chlorophyll field PAR (photosynthetically Active Radiation 400...700 nm), μmol m ⁻² s ⁻¹ measure, opaline quartz diffuser for cosine correction. The probe uses a special filter that optimizes the spectral response. Measuring range 0.1 μmol m ⁻² s ⁻¹ ...10·10 ³ μmol m ⁻² s ⁻¹ .	
LP471RAD	Radiometric probe for measuring the IRRADIANCE in the spectral range 400nm...1050nm, cosine correction diffuser. Measuring range: 1.0·10 ⁻³ mW/m ² ...2000 W/m ² .	
LP471UVA	Radiometric probe for measuring the IRRADIANCE in the UVA spectral range 315nm...400nm, peak at 360nm, quartz diffuser for cosine correction. Measuring range: 1.0·10 ⁻³ mW/m ² ... 2000 W/m ² .	
LP471UVB	Radiometric probe for measuring the IRRADIANCE in the UVB spectral range 280nm...315nm, peak at 305nm ... 310nm, quartz diffuser for cosine correction. Measuring range: 1.0·10 ⁻³ mW/m ² ... 2000 W/m ² .	
LP471UVC	Radiometric probe for measuring the IRRADIANCE in the UVC spectral range 220nm...280nm, peak at 260nm, quartz diffuser for cosine correction. Measuring range: 1.0·10 ⁻³ W/m ² ... 2000 W/m ² .	

RADIOMETRIC-PHOTOMETRIC PROBES FOR PORTABLE INSTRUMENTS

COD.	Description	
LP471BLUE	Radiometric probe for measuring the EFFECTIVE IRRADIANCE in the spectral range of the Blue light 380nm...550nm, diffuser for cosine correction. Measuring range: $1.0 \cdot 10^{-3} \text{ W/m}^2 \dots 2000 \text{ W/m}^2$.	
LP471P-A	Combined probe for measuring ILLUMINANCE (lux), with standard photopic response, and IRRADIANCE ($\mu\text{W/cm}^2$) in the UVA spectral range (315...400 nm, with peak at 360 nm). Both the sensors are equipped with diffuser for the correction according to the cosine law. Illuminance measuring range: $0.3 \text{ lux} \dots 200 \cdot 10^3 \text{ lux}$. Irradiance measuring range: $1.0 \text{ mW/m}^2 \dots 2000 \text{ W/m}^2$. This probe provides the ratio between UVA irradiance and illuminance in $\mu\text{W/lumen}$ (quantity of interest in museums).	
LP471A-UVeff	Combined probe for measuring the TOTAL EFFECTIVE IRRADIANCE (W/m^2) weighted according to the UV action curve. The probe is made of two sensors for the correct measure of the Total Effective Irradiance in the range 250...400nm. Both these sensors are equipped with a diffuser for the correction according to the cosine law. This probe supplies the Total effective irradiance (Eeff), the UV-CB effective irradiance and the UVA irradiance. Total effective irradiance measuring range: $0.010 \text{ W/m}^2 \dots 20 \text{ W/m}^2$. B_C effective irradiance measuring range: $0.010 \text{ W/m}^2 \dots 20 \text{ W/m}^2$ UVA irradiance measuring range: $0.1 \text{ W/m}^2 \dots 2000 \text{ W/m}^2$	
LP471 Silicon-Pyra	Pyranometer with silicon photodiode for measuring the GLOBAL SOLAR IRRADIANCE , diffuser for cosine correction. Spectral range 400...1100 nm. Measuring range: $1.0 \cdot 10^{-3} \dots 2000 \text{ W/m}^2$. Fixed cable 5m long, terminated with open wires.	
LP471PYRA	The probes LP471PYRA... consist of a pyranometer LPPYRA03, LPPYRA02 or LPPYRA10 and a SICRAM module equipped with a 5 or 10m cable for the connection to the instruments HD31, D09847, HD2102.1, HD2102.2, HD2302.0 and get a reading expressed directly in W/m^2 . LPPYRA03 is a second class pyranometer; LPPYRA02 is a first class pyranometer; LPPYRA10 is a "Secondary Standard" pyranometer.	
LPBL	Supporting and leveling base for the LP471... probes. NOT suitable for LP471LUM2 and LP471PYRA.	
LPBL3	Adjustable wall support for the LP471... probes. NOT suitable for LP471LUM2 and LP471PYRA.	

HD2302.0



HD2302.0 PHOTO-RADIOMETER

The HD2302.0 is a portable instrument with a large LCD display. It measures **illuminance**, **luminance**, **PAR** and **irradiance** (across VIS-NIR, UVA, UVB and UVC spectral regions or measurement of irradiance effective according to the UV action curve). The probes are equipped with the SICRAM automatic detection module: in addition to detection, the unit of measurement selection is also automatic. The factory calibration data are already memorized inside the probes. The Max, Min and Avg function calculate the maximum, minimum or average values. Other functions include: the relative measurement REL, the HOLD function, and the automatic turning off that can also be excluded. **The instruments have IP67 protection degree.**

INSTRUMENT TECHNICAL CHARACTERISTICS

Instrument

Dimensions (Length x Width x Height)	140x88x38mm
Weight	160g (complete with batteries)
Materials	ABS
Display	2x4½ digits plus symbols - 52x42mm Visible area: 52x42mm

Operating conditions

Operating temperature	-5...50°C
Storage temperature	-25...65°C
Working relative humidity	0...90%RH without condensation
Protection degree	IP67

Power

Batteries	3 1.5V type AA batteries
Autonomy	200 hours with 1800mAh alkaline batteries
Power absorbed with the instrument off	20µA

Measuring unit

lux - fcd - µmol/m²·s - cd/m² - W/m² - µW/cm²
µW/lumen

Connections

Input module for the probes 8-pole male DIN45326 connector

Technical characteristics of photometric and radiometric probes equipped with SICRAM module for the connection the instrument.

LP471PHOT probe for the measure of ILLUMINANCE				
Measuring range (lux):	0.10...199.99	...1999.9	...19999	...199.99·10 ³
Resolution (lux):	0.01	0.1	1	0.01·10 ³
Spectral range:	in agreement with standard photopic curve V(λ)			
α (temp. coefficient) f ₆ (T)	<0.05%K			
Calibration uncertainty:	<4%			
f ₁ (in agreement with photopic response V(λ)):	<6%			
f ₂ (response according to the cosine law):	<3%			
f ₃ (linearity):	<1%			
f ₄ (instrument reading error):	<0.5%			
f ₅ (fatigue):	<0.5%			
Class	B			
Drift after 1 year:	<1%			
Working temperature:	0...50°C			
Reference Standards	CIE n.69 - UNI 11142			

Photometric probe for **ILLUMINANCE** measurement, spectral response in agreement with standard photopic vision, diffuser for cosine correction. Measurement range: 0.10 lux...200·10³ lux.



LP471LUM2 probe for the measure of LUMINANCE				
Measuring range (cd/m ²):	1.0...1999.9	...19999	...199.99·10 ³	...1999.9·10 ³
Resolution (cd/m ²):	0.1	1	0.01·10 ³	0.1·10 ³
Optical angle:	2°			
Spectral range:	in agreement with standard photopic curve V(λ)			
α (temp. coefficient) f ₆ (T)	<0.05%K			
Calibration uncertainty:	<5%			
f ₁ (in agreement with photopic response V(λ)):	<8%			
f ₃ (linearity):	<1%			
f ₄ (instrument reading error):	<0.5%			
f ₅ (fatigue):	<0.5%			
Class	C			
Drift after 1 year:	<1%			
Working temperature:	0...50°C			
Reference Standards	CIE n.69 - UNI 11142			

Photometric probe for **LUMINANCE** measurement, spectral response in agreement with standard photopic vision, vision angle 2°. Measurement range: 1.0 cd/m²...2000·10³ cd/m².



Typical response curve: LP471PHOT and LP471LUM2

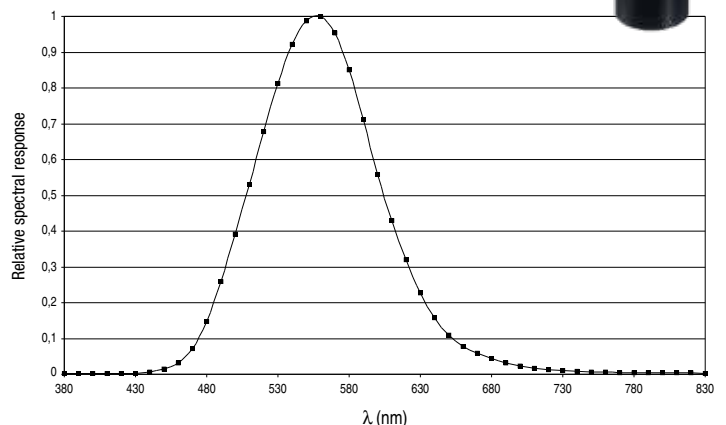

LP471PAR quantum radiometric probe for the measure of the photon flow across the chlorophyll range PAR			
Measuring range ($\mu\text{mol}\cdot\text{m}^{-2}\cdot\text{s}^{-1}$):	0.10...199.99	200.0...1999.9	2000...10000
Resolution ($\mu\text{mol}\cdot\text{m}^{-2}\cdot\text{s}^{-1}$):	0.01	0.1	1
Spectral range:	400nm...700nm		
Calibration uncertainty:	<5%		
f_2 (response according to the cosine law):	<6%		
f_3 (linearity):	<1%		
f_4 (instrument reading error):	± 1 digit		
f_5 (fatigue):	<0.5%		
Drift after 1 year:	<1%		
Working temperature:	0...50°C		

Quantum radiometric probe for the measurement of the photon flow across the chlorophyll range **PAR** (Photosynthetically Active Radiation 400nm...700nm), measurement in $\mu\text{mol}/\text{m}^2\cdot\text{s}$. Measurement range: $0.10 \mu\text{mol}\cdot\text{m}^{-2}\cdot\text{s}^{-1} \dots 10\cdot 10^3 \mu\text{mol}\cdot\text{m}^{-2}\cdot\text{s}^{-1}$.



Typical response curve: LP471PAR

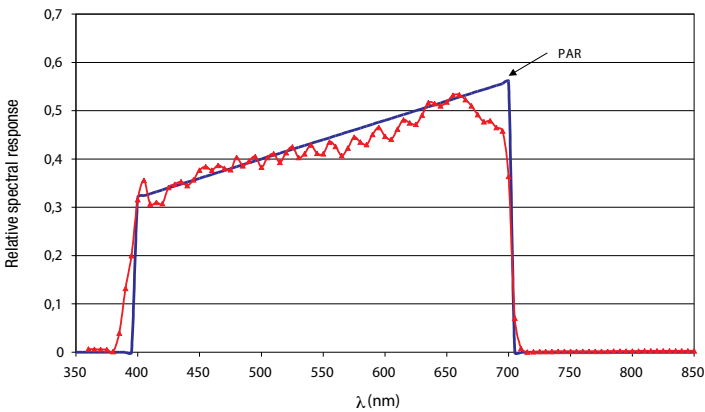

LP471UVA probe for the measure of UVA IRRADIANCE				
Measuring range (W/m^2):	$1.0\cdot 10^{-3}$... $999.9\cdot 10^{-3}$	1.000 ...19.999	20.00 ...199.99	200.0 ...1999.9
Resolution (W/m^2):	$0.1\cdot 10^{-3}$	0.001	0.01	0.1
Spectral range:	315nm...400nm (Peak 360nm)			
Calibration uncertainty:	<5%			
f_3 (linearity):	<1%			
f_4 (instrument reading error):	± 1 digit			
f_5 (fatigue):	<0.5%			
Drift after 1 year:	<2%			
Working temperature:	0...50°C			

Radiometric probe for **IRRADIANCE** measurement, in the 315nm...400nm, peak 360nm, UVA spectral range. Measurement range: $1.0\cdot 10^{-3}\text{W}/\text{m}^2 \dots 2000\text{W}/\text{m}^2$.



Typical response curve: LP471UVA

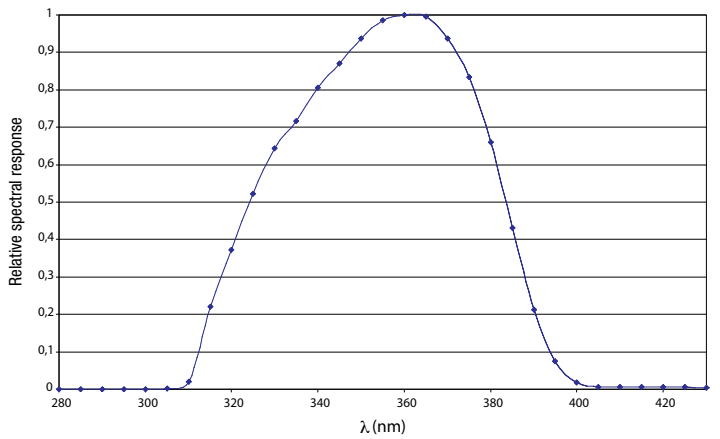

LP471RAD probe for the measure of IRRADIANCE				
Measuring range (W/m^2):	$1.0\cdot 10^{-3}$... $999.9\cdot 10^{-3}$	1.000 ...19.999	20.00 ...199.99	200.0 ...1999.9
Resolution (W/m^2):	$0.1\cdot 10^{-3}$	0.001	0.01	0.1
Spectral range:	400nm...1050nm			
Calibration uncertainty:	<5%			
f_2 (response according to the cosine law):	<6%			
f_3 (linearity):	<1%			
f_4 (instrument reading error):	± 1 digit			
f_5 (fatigue):	<0.5%			
Drift after 1 year:	<1%			
Working temperature:	0...50°C			

Radiometric probe for **IRRADIANCE** measurement in the spectral range 400nm...1050nm, diffuser for cosine correction. Measurement range: $1.0\cdot 10^{-3}\text{W}/\text{m}^2 \dots 2000\text{W}/\text{m}^2$.



Typical response curve: LP471RAD

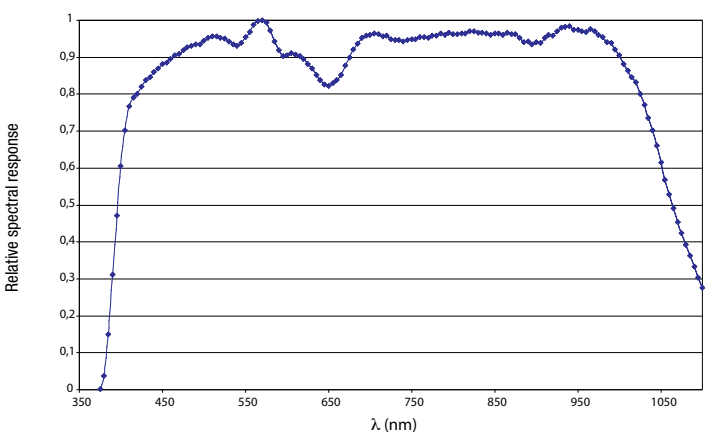

LP471UVB probe for the measure of UVB IRRADIANCE				
Measuring range (W/m^2):	$1.0\cdot 10^{-3}$... $999.9\cdot 10^{-3}$	1.000 ...19.999	20.00 ...199.99	200.0 ...1999.9
Resolution (W/m^2):	$0.1\cdot 10^{-3}$	0.001	0.01	0.1
Spectral range:	280nm...315nm (Peak 305nm...310nm)			
Calibration uncertainty:	<5%			
f_3 (linearity):	<2%			
f_4 (instrument reading error):	± 1 digit			
f_5 (fatigue):	<0.5%			
Drift after 1 year:	<2%			
Working temperature:	0...50°C			

Radiometric probe for **IRRADIANCE** measurement, in the spectral range 280nm...315nm, peak 305nm ... 310nm, Measurement range: $1.0\cdot 10^{-3}\text{W}/\text{m}^2 \dots 2000\text{W}/\text{m}^2$.



Typical response curve: LP471UVB

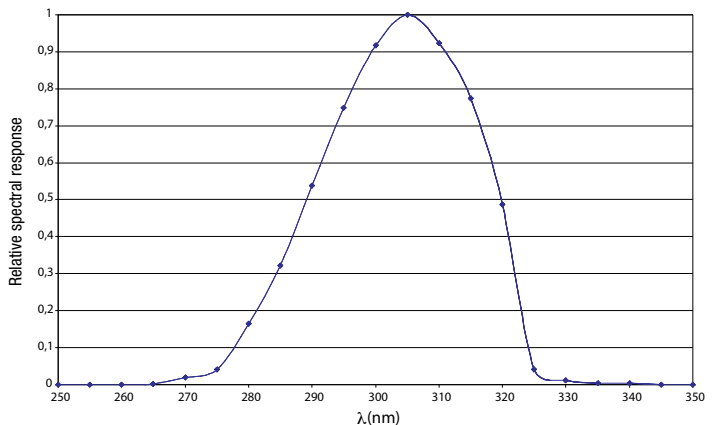

LP471UVC probe for the measure of UVC IRRADIANCE				
Measuring range (W/m ²):	1.0·10 ⁻³ ...999.9·10 ⁻³	1.000 ...19.999	20.00 ...199.99	200.0 ...1999.9
Resolution (W/m ²):	0.1·10 ⁻³	0.001	0.01	0.1
Spectral range:	220nm...280nm (Peak 260nm)			
Calibration uncertainty:	<5%			
f ₃ (linearity):	<1%			
f ₄ (instrument reading error):	±1 digit			
f ₅ (fatigue):	<0.5%			
Drift after 1 year:	<2%			
Working temperature:	0...50°C			

Radiometric probe for **IRRADIANCE** measurement, in the spectral range 220nm...280nm, peak 260nm, UVC. Measurement range: 1.0·10⁻³W/m²...2000W/m².

Typical response curve: LP471UVC

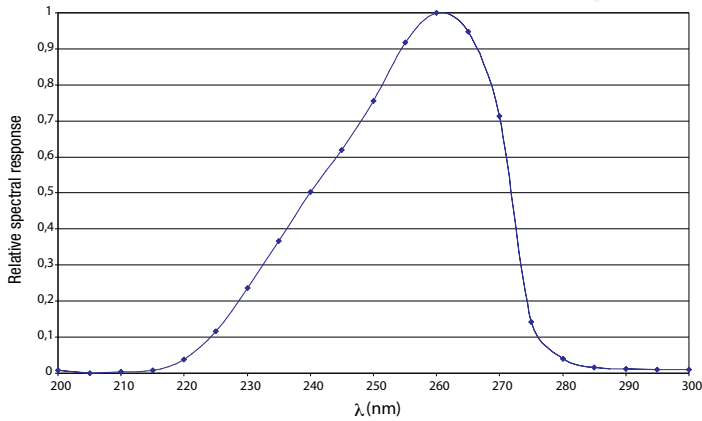

LP471 A-UVeff probe for the measure of TOTAL EFFECTIVE IRRADIANCE weighted according to the UV action curve (CEI EN 60335-2-27)	
Total Effective Irradiance	
Measuring range (W _{eff} /m ²):	0.010 ... 19.999
Resolution (W _{eff} /m ²):	0.001
Spectral range:	UV action curve for measuring erythema (250 nm...400 nm)
Calibration uncertainty:	<15%
f ₃ (linearity):	<3%
f ₄ (instrument reading error):	±1 digit
f ₅ (fatigue):	<0.5%
Drift after 1 year:	<2%
Working temperature:	0...50°C
Reference standard	CEI EN 60335-2-27
UVA Irradiance	
Measuring range (W _{eff} /m ²):	0.01 ... 1999.9
Resolution (W _{eff} /m ²):	0.1
Spectral range:	315 nm ... 400 nm
UV_BC Irradiance	
Measuring range (W _{eff} /m ²):	0.010 ... 19.999
Resolution (W _{eff} /m ²):	0.001
Spectral range:	250 nm ... 315 nm

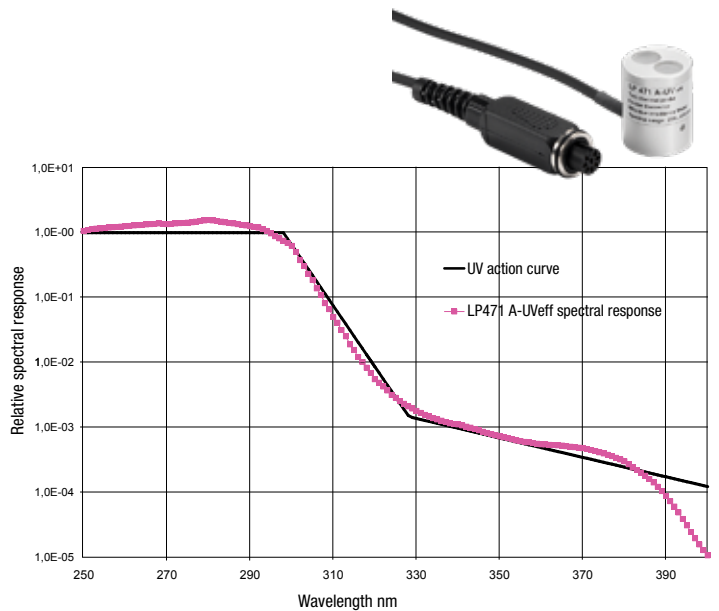

Combined probe LP471P-A with two sensors for the measure of ILLUMINANCE and UVA IRRADIANCE				
Illuminance				
Measuring range (lux):	0.3...199.9	...1999.9	...19999	...199.99·10 ³
Resolution (lux):	0.01	0.1	1	0.01·10 ³
Spectral range:	in agreement with standard photopic curve V(λ)			
α (temp. coefficient) f ₆ (T)	<0.05%K			
Calibration uncertainty:	<4%			
f ₁ (in agreement with photopic response V(λ)):	<6%			
f ₂ (response according to the cosine law):	<3%			
f ₃ (linearity):	<1%			
f ₄ (instrument reading error):	<0.5%			
f ₅ (fatigue):	<0.5%			
Class:	B			
Drift after 1 year:	<1%			
Working temperature:	0...50°C			
Reference Standards	CIE n.69 - UNI 11142			

Please refer to the spectral response of the LP471PHOT probe

UVA Irradiance				
Measuring range (μW/cm ²):	0.10...199.99	...1999.9	...19999	...199.99·10 ³
Resolution (μW/cm ²):	0.01	0.1	1	0.01·10 ³
Spectral range:	315nm...400nm (Peak 360nm)			
Calibration uncertainty:	<5%			
f ₂ (response according to the cosine law):	<6%			
f ₃ (linearity):	<1%			
f ₄ (instrument reading error):	±1 digit			
f ₅ (fatigue):	<0.5%			
Drift after 1 year:	<2%			
Working temperature:	0...50°C			

Please refer to the spectral response of the LP471UVA probe



LPSILICON-PYRA probe for the measure of GLOBAL SOLAR RADIATION				
Measurement range (W/m ²):	1.0·10 ⁻³ ... 999.9·10 ⁻³	1.000...19.999	20.00...199.99	200.0...1999.9
Resolution (W/m ²):	0.1·10 ⁻³	0.001	.01	0.01
Spectral range:	400 nm ... 1100 nm			
Calibration uncertainty:	<3%			
f ₂ (response according to the cosine law):	<3%			
f ₃ (linearity):	<1%			
f ₄ (instrument reading error):	±1 digit			
f ₅ (fatigue):	<0.5%			
Drift after 1 year:	<2%			
Working temperature:	0...50°C			

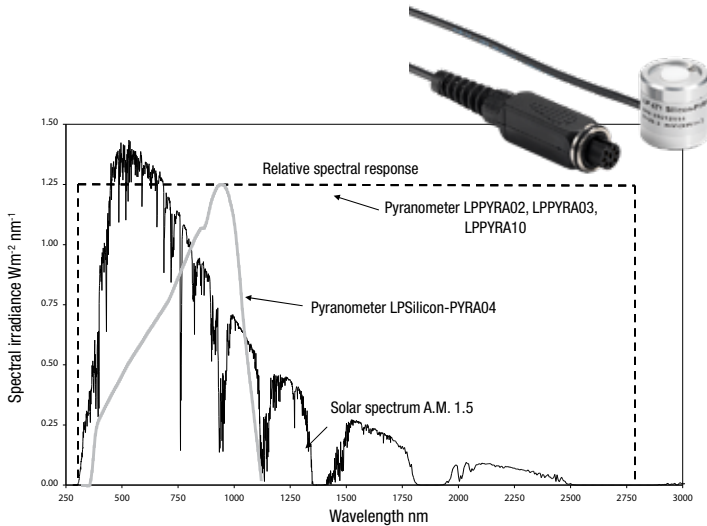

LP471BLUE probe for the measure of IRRADIANCE in spectral band of BLUE LIGHT				
Measurement range (W/m ²):	1.0·10 ⁻³ ... 999.9·10 ⁻³	1.000...19.999	20.00...199.99	200.0...1999.9
Resolution (W/m ²):	0.1·10 ⁻³	0.001	.01	0.01
Spectral range:	380 nm ... 550 nm. Action curve for damages of Blue light B(λ)			
Calibration uncertainty:	<10%			
f ₂ (response according to the cosine law):	<6%			
f ₃ (linearity):	<3%			
f ₄ (instrument reading error):	±1 digit			
f ₅ (fatigue):	<0.5%			
Drift after 1 year:	<2%			
Working temperature:	0...50°C			

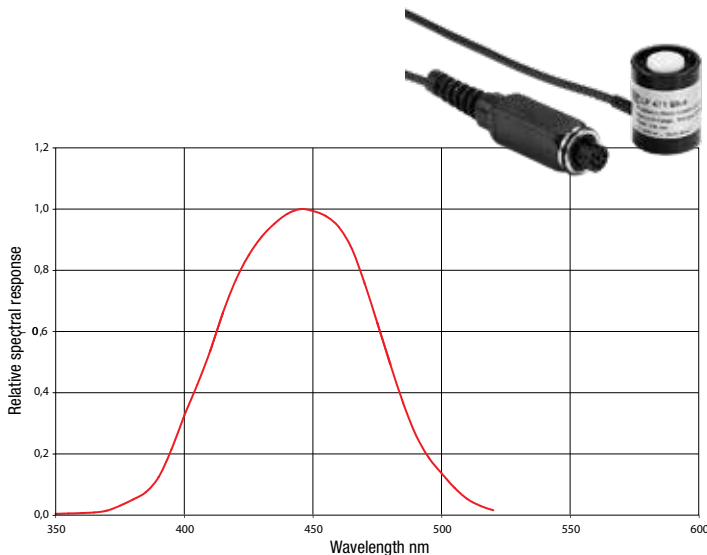

The radiometric probe LP471-BLUE measures irradiance (W/m²) in spectral band of blue light. The probe consists of a photodiode plus an appropriate filter and it is provided with diffuser for proper measure in accordance with the cosine law. The spectral response curve of the probe allows to measure the radiation effective for damages caused by blue light (curve B(λ)) according to the standards ACGIH / ICNIRP) in the spectral range from 380nm to 550nm. The radiation optics in this portion of the spectrum can produce photochemical damage to the retina. Another field of application is the monitoring of the probe irradiance from blue light used in the treatment of neonatal jaundice.

ORDERING CODES:

HD2302.0: The kit consists of the instrument HD2302.0, 3 1.5V alkaline batteries, operating manual, case. **The probes must be ordered separately.**

Probes complete with SICRAM module

LP471PHOT: Photometric probe for measuring **ILLUMINANCE** complete with SICRAM module, spectral response in agreement with standard photopic vision, Class B according to CIE n°69, diffuser for cosine correction. Measurement range: 0.10 lux...200·10³ lux.

LP471LUM2: Photometric probe for measuring **LUMINANCE** complete with SICRAM module, spectral response in agreement with standard photopic vision, vision angle 2°. Measurement range: 1.0 cd/m²...2000·10³ cd/m².

LP471PAR: Quantum radiometric probe for the measurement of the photon flow across the chlorophyll range **PAR** (Photosynthetically Active Radiation 400nm...700nm) complete with SICRAM, measurement in μmol·m⁻²·s⁻¹, diffuser for cosine correction. Measurement range: 0.10 μmol·m⁻²·s⁻¹...10·10³ μmol·m⁻²·s⁻¹.

LP471RAD: Radiometric probe for measuring **IRRADIANCE** equipped with SICRAM module; in the 400nm...1050nm spectral range, diffuser for cosine correction. Measurement range: 1.0·10⁻³W/m²...2000W/m².

LP471UVA: Radiometric probe for measuring **IRRADIANCE** equipped with SICRAM module; in the 315nm...400nm, peak 360nm, **UVA** spectral range, quartz diffuser for cosine correction. Measurement range: 1.0·10⁻³W/m²...2000 W/m².

LP471UVB: Radiometric probe for measuring **IRRADIANCE** equipped with SICRAM module, in the 280nm...315nm, peak 305nm ... 310nm, **UVB** spectral range, quartz diffuser for cosine correction. Measurement range: 1.0·10⁻³W/m²...2000 W/m².

LP471UVC: Radiometric probe for measuring **IRRADIANCE** equipped with SICRAM module, in the 220nm...280nm, peak 260nm, **UVC** spectral range, quartz diffuser for cosine correction. Measurement range: 1.0·10⁻³W/m²...2000 W/m².

LP471 BLUE: Radiometric probe for measuring **IRRADIANCE** (W/m²) in spectral band of blue light equipped with SICRAM module. Spectral range: 380 nm...550 nm, quartz diffuser for cosine correction. Measurement range: 1.0·10⁻³Weff /m² ... 2000 Weff /m².

LP471P-A: Combined probe for measuring **ILLUMINANCE** (lux), with standard photopic response, and **IRRADIANCE** (μW/cm²) in the UVA spectral range (315...400 nm, with peak at 360 nm). Both the sensors are equipped with diffuser for the correction according to the cosine law.

Illuminance measuring range: 0.3 lux ... 200·10³ lux

Irradiance measuring range: 1.0 mW/m² ... 2000 W/m².

This probe provides the ratio between UVA irradiance and illuminance in μW/lumen (quantity of interest in museums). The probe is equipped with SICRAM module and cable 2m long.

LP471 A-UVeff: Combined probe for measuring the **TOTAL EFFECTIVE IRRADIANCE** (W/m²) weighted according to the UV action curve. The probe is made of two sensors for the correct measure of the Total Effective Irradiance in the range 250...400nm. Both these sensors are equipped with a diffuser for the correction according to the cosine law.

This probe supplies the Total effective irradiance (Eeff), the UV-CB effective irradiance and the UVA Irradiance.

Total effective irradiance measuring range: 0.010 W/m² ... 20 W/m².

B_C effective irradiance measuring range: 0.010 W/m² ... 20 W/m².

UVA irradiance measuring range: 0.1 W/m² ... 2000 W/m²

The probe is equipped with the SICRAM module and a cable 2m long.

LP471PYRA02..., LP471PYRA03..., LP471PYRA10..., LP471 Silicon-PYRA...

LPBL: Base with levelling device for all the above-described probes except for the probes LP471LUM2 and LP471PYRA.

LPBL3: Jointed support for all the above-described probes except for LP471LUM2 and LP471PYRA.



D09721



**D09721
QUANTUM PHOTO-RADIOMETER AND THERMOMETER DATA-LOGGER**

The **D09721** quantum photo-radiometer and thermometer data logger has been designed for measuring illuminance, irradiance, luminance and temperature. The instrument has two inputs, A and B, and automatically detects the sensors, whether illuminance, irradiance, luminance or temperature and can provide a view of the difference between the two inputs. As the probes are interchangeable, it is possible to choose the most suitable combination for all applications without having to recalibrate the instrument. The **D09721** can take illuminance measurements in lux and in fcd (foot-candle), irradiance measurements in W/m², in μW/cm² and in μmol·m⁻²·s⁻¹, luminance measurements in cd/m² and temperature measurements in °C or °F.

With the data logger function the instrument stores up to 30,000 readings with selectable sampling interval from 1 second to 12 hours.

The data acquired can then be downloaded to a Personal Computer or a printer by means of the opto-insulated serial line RS232C. For each value stored the date and time of acquisition are indicated; each acquisition block is ended with a report which provides the maximum, minimum and mean values. With the Serial Output function it is possible to obtain the instantaneous values measured by the instrument at the output of the serial line RS232C, in order to send them to a printer or a computer. Other functions such as Hold (which blocks the display), Rel (for taking relative measurements), Record (for storing the maximum, minimum and mean values) and Q (integration in time of the measurements with alarm threshold) further enrich the instrument's performance. Thanks to its versatility and to its storage capacity, the instrument is suitable for a wide variety of applications, both in the field and in the laboratory.

PROBE CONNECTION

The instrument **D09721** has two circular DIN 45326 8-pole connectors (A and B) which allow the connection of Delta OHM probes for measuring temperature, type TP870, and probes for measuring the photometric and radiometric intensity, type LP9021. The probe model should be chosen according to the specific application.

INSTRUMENT TECHNICAL DATA

Inputs / type of measurement	2: photometric / radiometric or temperature
Connector	DIN 45326 8-pole
Measuring range	
Photometric measurements	0.1...200.000 lux 1...20.000 fcd 1...2.000.000 cd/m ²
Radiometric measurements	1·10 ⁻³ ...2000 W/m ² 0.1...200.000 μW/cm ² 0.1...200.000 μmol·m ⁻² ·s ⁻¹
Q energy	depends on the active measurements unit
Integration time	19 hours, 59 minutes, 59 seconds
No. conversions per second	2
Working temperature	-5...+50°C
Working relative humidity	0...90% R.H. (no condensation)
Serial output	RS232C 300...19200 baud (galvanically insulated)
Display	Double LCD 12.5 mm
Functions	Auto power off / Autorange / Hold / Record Maximum / Minimum / Mean / Relative A-B / Energy
Memory	512kB (FLASH) corr. to 30,000 measurements
Power supply	9Vdc alkaline battery
Autonomy	Approx. 30 hours (continuous duty)
Weight / dimensions	320 gr. / 215x73x38 mm

ORDERING CODES:

D09721: Instrument, user's manual, carrying case, DeltaLog1 software downloadable from Delta OHM website, 9V battery. **Probes and cables must be ordered separately.**



LP9021PHOT: Photometric probe for measuring **ILLUMINANCE**; photopic filter in compliance with CIE n° 69 - UNI 11142, diffuser for correction according to the cosine law.



LP9021RAD: Radiometric probe for measuring the **IRRADIANCE** of artificial light sources, irradiance of the sun.



LP9021PAR: Quantum-radiometric probe for measuring the **PHOTONS FLOW** in the chlorophyll field PAR (photosynthetically Active Radiation 400nm...700nm), μmol·m⁻²·s⁻¹ measure, cosine correction diffuser.



LP9021UVA: Radiometric probe for measuring **IRRADIANCE** in the ultraviolet field. Suitable for measuring radiation in the ultraviolet region A.



LP9021UVB: Radiometric probe for measuring **IRRADIANCE** in the ultraviolet field. Suitable for measuring radiation in the ultraviolet region **B**.



LP9021UVC: Radiometric probe for measuring **IRRADIANCE** in the ultraviolet field. Suitable for measuring radiation in the ultraviolet region **C**.



LP9021LUM2: Probe for measuring **LUMINANCE**, measuring range from 1 to $1999 \cdot 10^3$ cd/m². Measuring angle 2°. CIE filter for correction of the response according to the human eye, CIE n°69-UNI11142.

LPBL: Stand for supporting and levelling probes, except for LP9021LUM2.
TP870.0: Immersion temperature probe, Pt100 sensor, diam. 3x230 mm, measuring range -50...+250°C.
TP870C.0: Contact temperature probe, Pt100 sensor, diam. 4x230 mm, measuring range -50...+250°C.
TP870P.0: Penetration temperature probe, Pt100 sensor, diam. 4x150 mm, measuring range -50...+250°C.
TP870A.0: Air temperature probe, Pt100 sensor, diam. 4x230 mm, measuring range -50...+250°C.
C.205: Serial connection cable with USB connector for PC and Sub-D 9-pole connector for the instrument. The cable has a built-in USB/RS232 converter and connects the instrument **D09721** directly to the USB port of the PC.
9CPRS232: Sub D 9-pole Female/Female RS232 null-modem cable for **D09721**.



Probe Model	Measuring range	Spectral measuring range	Calibration uncertainty
LP9021PHOT	0.1 ... 200000 lux	CIE N°69 Class C	<4%
LP9021RAD	1mW/m ² ... 2000 W/m ²	450 ... 950nm	<5%
LP9021PAR	0.1 μmol m ⁻² s ⁻¹ ... 20000 μmol m ⁻² s ⁻¹	400 ... 700nm	<5%
LP9021UVA	1 mW/m ² ... 2000 W/m ²	315 ... 400nm	<5%
LP9021UVB	1 mW/m ² ... 2000 W/m ²	280 ... 315nm	<5%
LP9021UVC	1 mW/m ² ... 2000 W/m ²	200 ... 280nm	<5%
LP9021LUM2	1 ... $2 \cdot 10^6$ cd/m ²	CIE N°69 Class C	<5%

INSTRUMENT UNCERTAINTY			
	at 25°C +/-	from -5°C to 50°C +/-	Measuring range +/-
Instrument base uncertainty	0.1% ... 1 digit	0.2% ... 1 digit	
Temperature measure of instrument with probe	0.6°C 0.4°C 2°C	0.6°C + 0.01°C/°C 0.4°C + 0.01°C/°C 2°C + 0.01°C/°C	-50 ... +50°C +50 ... +200°C +200 ... +400°C

TEMPERATURE PROBES OF THE SERIES TP870				
Code	Description	Drawing	τ Sec.	Temp/°C
TP870.0	Immersion probe ø 3 x 230 mm		3"A	-50/+250
TP870P.0	Penetration probe ø 4 x 150 mm		3"A	-50/+250
TP870C.0	Contact probe ø 4 x 230 mm		12"C	-50/+250
TP870A.0	Air probe ø 4 x 230 mm		3"B	-50/+250

A) Time constant in water at 100 ° C / B) Time constant detected in contact with metal surface at 200 ° C / C) Time constant in air at 100 ° C.
Notes: Time constant to respond to the 63% of the temperature variation.

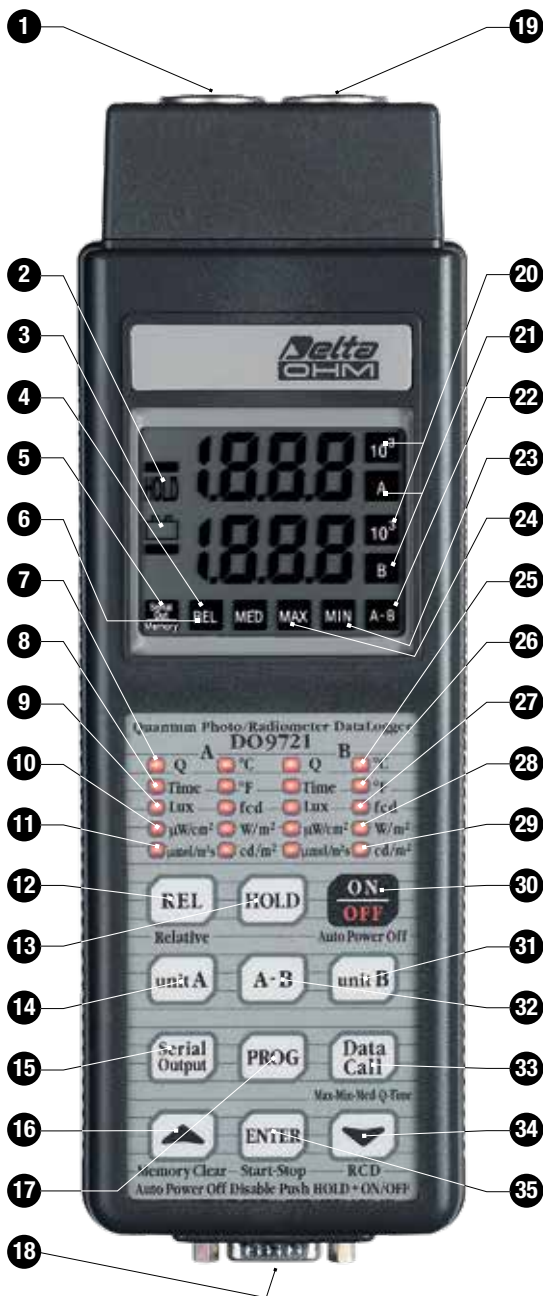

- 1 Input A, DIN 45326 8-pole connector.
- 2 HOLD symbol, the measurement refers to the moment in which the HOLD key was pressed.
- 3 Battery symbol: flashes during RECORD function, permanently lit if the battery is running low.
- 4 REL symbol, indicates that the instrument is making a relative measurement.
- 5 Serial Out/Memory. Fixed symbol: the instrument is storing. Flashing symbol: serial output is enabled.
- 6 MED symbol: the display shows the mean values found during RCD function.
- 7 Q: instrument in Q-energy function, flashes when it has reached the limit.
- 8 Time: the display indicates the integration time, if flashing it has reached the time programmed for integration.
- 9 Lux: the led indicates that the measurement is in lux.
- 10 $\mu\text{W}/\text{cm}^2$: the led indicates that the measurement is in $\mu\text{W}/\text{cm}^2$.
- 11 $\mu\text{mol}\cdot\text{m}^{-2}\cdot\text{s}^{-1}$: the led indicates that the measurement is in $\mu\text{mol}\cdot\text{m}^{-2}\cdot\text{s}^{-1}$.
- 12 REL key: shows the difference between the current value and the value stored when the REL key is pressed.
- 13 HOLD key for blocking the reading.
- 14 Unit A key: for selecting the measurement unit for input A, depending on the probe fitted. When turned to P0 mode, it sets the Q-energy and Time limits for input A.
- 15 Serial Output: activates data transmission at the RS232C serial output.
- 16 ▲ (Memory clear): increases the parameters in programming mode; when held down it erases the "RCD" memory; when pressed with P1, it erases the permanent memory.
- 17 PROG key: activates the programs P0... P1... P... of the different instrument functions.
- 18 Connector for RS232C (SUB D male 9 pole).
- 19 Input B, DIN 45326 8-pole connector.
- 20 Symbol 10^3 : indicates multiplication factor 10^3 for the respective channel.
- 21 Symbols A and B: for magnitudes Q and T indicate the channel selected.
- 22 A-B: the bottom display shows the difference between A and B. The top display shows A.
- 23 MIN symbol: the display shows the minimum values found during RCD function.
- 24 MAX symbol: the display shows the maximum values found during RCD function.
- 25 °C: the led indicates that the temperature measurement is in degrees centigrade.
- 26 °F: the led indicates that the temperature measurement is in degrees Fahrenheit.
- 27 fcd: the led indicates that the measurement is in fcd (foot-candle).
- 28 W/m^2 : the led indicates that the measurement is in W/m^2 .
- 29 cd/m^2 : the led indicates that the measurement is in cd/m^2 .
- 30 On/Off key: for switching the instrument on or off.
- 31 Unit B key: for selecting the measurement unit for input B, depending on the probe fitted. When turned to P0 mode, it sets the Q-energy and Time limits for input B.
- 32 A-B key: shows the difference between the inputs.
- 33 Data Call key (Max-Min-Med-Q-Time): recalls on the display the maximum, mean, minimum, Q and Time values of each input.
- 34 ▼ (RCD): starts and stops the RECORD function, in programming mode it decreases the parameter shown.
- 35 ENTER key: starts and stops storage, confirms the parameters set during programming.

A) Amplified temperature probe with Pt100 platinum-sensitive element

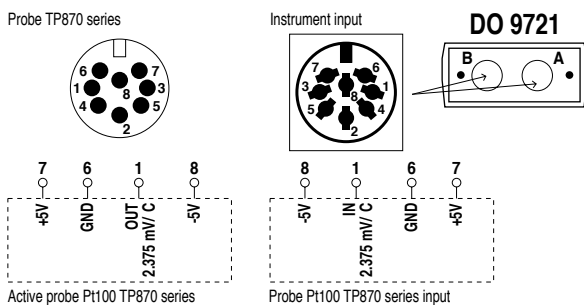

B) Probes for photometric and radiometric measurements

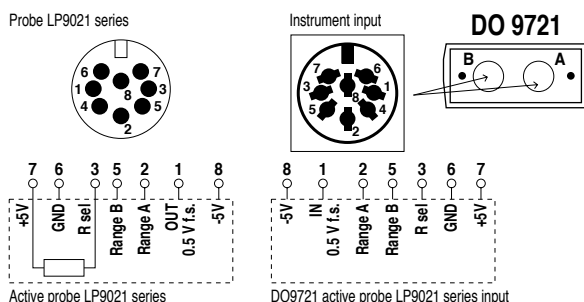

LPPHOT01, LPPAR01, LPRAD01, LPUVA01, LPUVB01
LPUVC01, LPPHOT01S



LPPHOT01, LPRAD01, LPPAR01, LPUVA01, LPUVB01, LPUVC01 PHOTO-METRIC/RADIOMETRIC PROBES WITH mV SIGNAL OUTPUT. LPPHOT01S WITH RS485 MODBUS-RTU OUTPUT

The probes of the series LP...01 allow measurement of photometric and radiometric quantities such as illuminance (lux), irradiance (W/m^2) across VIS-NIR, UVA, UVB, UVC spectral regions, the number of photons per time unit and area in the PAR region (400nm ... 700nm).

In probes LP...01 there is no need for external power supply. Output signal in mV is given through a resistor shunting the photodiode ends. Photocurrent generated by the photodiode when hit by light, is converted to a potential difference, which is read by a voltmeter. Once the DDP (Potential Difference) has been read, the measured value can be calculated through the calibration factor. **All probes are individually calibrated and the calibration factor is shown both on the probe housing and on the user manual and is specific to that probe.** LP...01 probes are equipped with cosine corrected diffuser. In probes for UV measurements the diffuser is made of sanded quartz, for the other probes, the diffuser is commonly made of acrylic material or teflon® (LPPHOT01). LP...01 probes are suitable for indoor applications which requires the constant monitoring of the quantities specified. The output signal can be amplified or converted into a 4...20mA or 0...10Vdc signal by using a converter of the series HD978TR3 (4...20mA) and HD978TR4 (0...10Vdc) for DIN rail attachment, or the wall mounting types HD978TR5 (4...20mA) and HD978TR6 (0...10Vdc).

Installing the probes

Once the installation place has been decided, the connections between the probe and the voltmeter should be provided; the voltmeter should have proper scales of measurement. The connection diagram of the probe output cables is shown in the user manual. For measurements in weather and agriculture stations or in nursery-gardening systems, the probe reference plane should be mounted parallel to the ground; in this case, the probe shall be mounted on a LPBL (optional) support provided with bubble level.

Probe description

LPPHOT01:

The LPPHOT01 probe measures illuminance (lux) defined as the ratio between the luminous flux (lumen) passing through a surface and the surface area (m^2).

The spectral response curve of a photometric probe is equal to the one of the human eye, known as standard photopic curve $V(\lambda)$. The difference in spectral response between LPPHOT01 and the standard photopic curve $V(\lambda)$ is calculated by means of the error f_1' . The calibration of the probe is performed by comparing it to a luxmeter calibrated by a Primary Metrological Institute. All calibration procedures follow the CIE publication No 69 (1987) "Method of Characterizing

Illuminance Meters and Luminance Meters". The calibration is carried out by illuminating the probe with a standard illuminant A.

TECHNICAL SPECIFICATIONS

Typical sensitivity:	0.5 ... 1.5 mV/klux
Spectral range:	$V(\lambda)$
Calibration accuracy:	<4%
f_1' ($V(\lambda)$ match error):	<6%
f_2 (cosine response/directional error):	<3%
f_3 (linearity):	<1%
f_5 (fatigue):	<0.5%
Operating temperature:	0...50°C
Output impedance:	0.5 ... 1 kΩ



Typical spectral response LPPHOT01

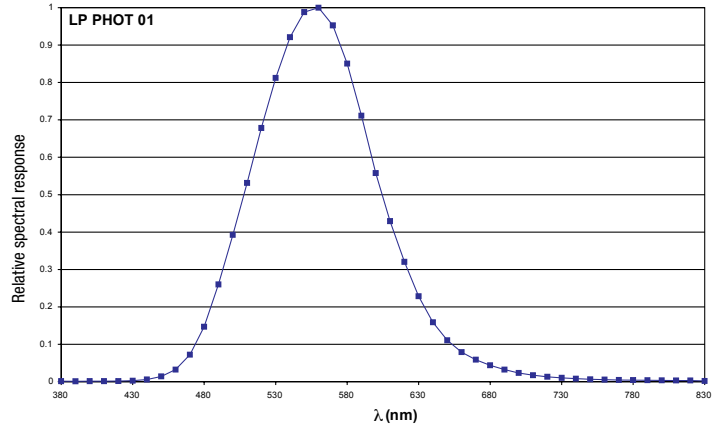

LPRAD01:

The LPRAD01 probe measures irradiance (W/m^2) defined as the ratio between the radiant flux (W) passing through a surface and the surface area (m^2) in the VIS-NIR (400nm...1050nm) spectral range. These particular features apply to an instrument suitable for measurements in visible and near infrared fields. **Probe calibration is carried out by using 577 and 579 nm lines of a Xe-Hg lamp, filtered through a special interferential filter.**

TECHNICAL SPECIFICATIONS

Typical sensitivity:	2.6 $\mu V/(\mu W/cm^2)$
Measuring range:	0 ... 200 mW/cm^2
Spectral range:	$\approx 400nm... \approx 1050nm$
Calibration accuracy:	<6%
f_2 (cosine response/directional error):	<6%
Operating temperature:	0 ... 50°C
Output impedance:	1 kΩ



Typical spectral response LPRAD01

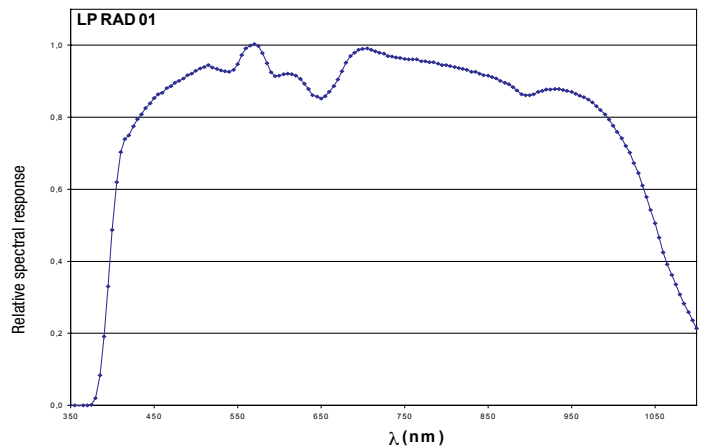

LPUVA01:

The LPUVA01 probe measures irradiance (W/m^2) defined as the ratio between the radiant flux (W) passing through a surface and the surface area (m^2) in the UVA (315 nm ... 400 nm) spectral range. Thanks to a new type of photodiode, LPUVA01 is blind to visible and infrared light.

Probe calibration is carried out by using a 365 nm line of a Xe-Hg lamp, filtered through a special interferential filter. Measurement is carried out by comparison with the primary standards, assigned to Delta OHM Metrological Laboratory.

This probe can be used in all processes where ultraviolet lamp emission needs to be monitored: resins and adhesives polymerization, as well as tanning lamps.

TECHNICAL SPECIFICATIONS

Typical sensitivity: 2.6 $\mu\text{V}/(\mu\text{W}/\text{cm}^2)$
 Measuring range: 0...200 mW/cm^2
 Typical spectral range: peak at ≈ 360 nm and FWHM 60 nm
 Calibration accuracy: <6%
 Working temperature: 0...50°C
 Output impedance: 1 k Ω



Typical spectral response LPUVA01

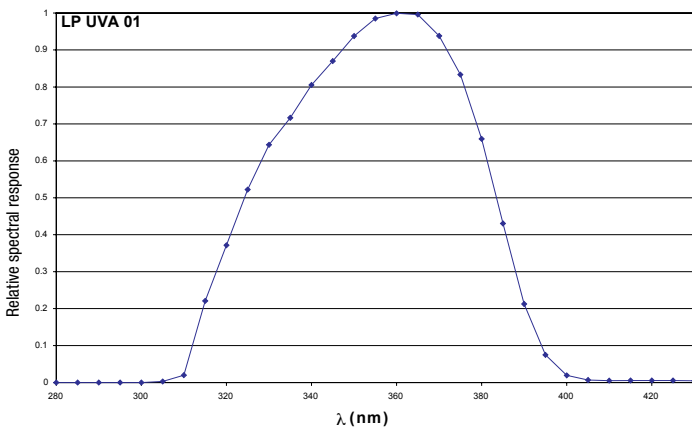

LPUVB01:

The LPUVB01 probe measures irradiance (W/m^2) defined as the ratio between the radiant flux (W) passing through a surface and the surface area (m^2) in the UVB (280 nm ...315 nm) spectral range. Thanks to a new type of photodiode, LPUVB01 is blind to visible and infrared light. **Probe calibration is carried out by using a 313 nm line** of a Xe-Hg lamp, filtered through a special interferential filter. Measurement is carried out by comparison with the primary standards, assigned to Delta OHM Metrological Laboratory.

TECHNICAL SPECIFICATIONS

Typical sensitivity: 0.19 $\mu\text{V}/(\mu\text{W}/\text{cm}^2)$
 Measuring range: 0...200 mW/cm^2
 Typical spectral range: peak at ≈ 305 nm and FWHM 31 nm
 Calibration accuracy: <8%
 Working temperature: 0...50°C
 Output impedance: 2 k Ω



Typical spectral response LPUVB01

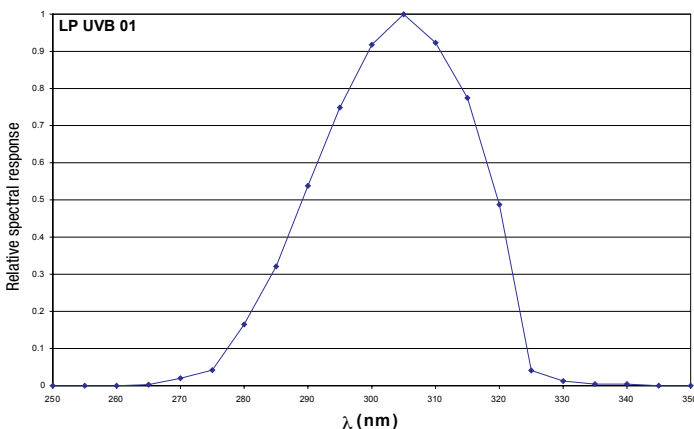

LPUVC01:

The LPUVC01 probe measures irradiance (W/m^2) defined as the ratio between the radiant flux (W) passing through a surface and the surface area (m^2) in the UVC (200nm ...280nm) spectral range. Thanks to a new type of photodiode, LPUVC01 is blind to visible and infrared light. **The probe calibration is carried out by measuring irradiance coming from an Hg lamp at 254nm.**

TECHNICAL SPECIFICATIONS

Typical sensitivity: 0.19 $\mu\text{V}/(\mu\text{W}/\text{cm}^2)$
 Measuring range: 0...200 mW/cm^2
 Typical spectral range: peak at 260 and FWHM 32nm
 Calibration accuracy: <10%
 Working temperature: 0...50°C
 Output impedance: 2 k Ω



Typical spectral response LPUVC01

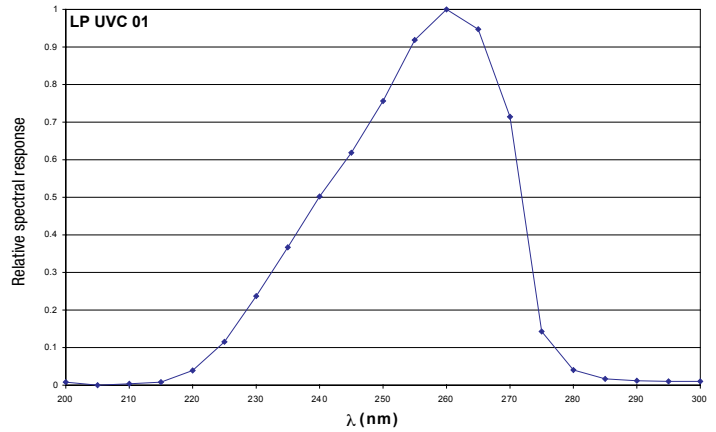

LPPAR01:

The LPPAR01 probe measures the ratio between the number of photons that strike a surface in one second, in the 400nm ... 700nm spectral range and the surface area (m^2). This quantity is defined as PAR: Photosynthetically Active Radiation.

The probe calibration is carried out by using an halogen lamp, with a known spectral irradiance in a specific spectral range.

Temperature slightly affects the probe spectral response.

The diffuser and the probe particular structure, allow the response to the variation of the light incidence angle on the diffuser, to be cosine corrected.

TECHNICAL SPECIFICATIONS

Typical sensitivity: 30 $\mu\text{V}/(\mu\text{mol}\cdot\text{m}^{-2}\cdot\text{s}^{-1})$
 Measuring range: 0...5000 $\mu\text{mol}\cdot(\text{m}^{-2}\cdot\text{s}^{-1})$
 Typical spectral range: 400 nm ... 660 nm
 Calibration accuracy: <6%
 t_2 (cosine response/directional error): <6%
 Operating temperature: 0...50°C
 Output impedance: 1 k Ω



Typical spectral response LPPAR01

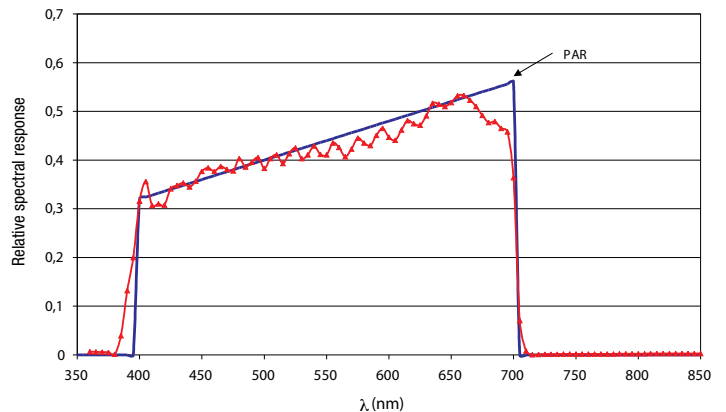

ORDERING CODES:

LPPHOT01: Photometric probe for measuring ILLUMINANCE, CIE photopic filter, diffuser for correction according to the cosine law. mV per klux output, cable 5m long.

LPRAD01: Radiometric probe for measuring IRRADIANCE, diffuser for correction according to the cosine law. mV per mW/cm^2 output, cable 5m long.

LPPAR01: Radiometric probe for measuring PHOTONS FLUX in the range of PAR (Photosynthetically Active Radiation). Cosine correction. mV per $\mu\text{mol}/\text{m}^2\cdot\text{s}$ output, cable 5m long.

LPUVA01: Radiometric probe for measuring IRRADIANCE in the UVA (315...400nm). $\mu\text{V}/\mu\text{Wcm}^{-2}$ output, cable 5m long.

LPUVB01: Radiometric probe for measuring IRRADIANCE in the UVB (280...315nm). $\mu\text{V}/\mu\text{Wcm}^{-2}$ output, cable 5m long.

LPUVC01: Radiometric probe for measuring IRRADIANCE in the UVC (200...280nm). $\mu\text{V}/\mu\text{Wcm}^{-2}$ output, cable 5m long.

LPBL: Base with levelling device. On request for assembly with the probes at the time of placing the order.

HD978TR3: Configurable signal converter amplifier with 4...20mA (20...4mA) output. Input measuring range -10...+60mV. Default setting 0...20mV. For DIN rail attachment. Minimum measuring range 2mV.

HD978TR4: Configurable signal converter amplifier with 0...10Vdc (10...0Vdc) output. Input measuring range -10...+60mV. Default setting 0...20mV. For DIN rail attachment. Minimum measuring range 2mV.

HD978TR5: Configurable signal converter amplifier with 4...20mA (20...4mA) output. Input measuring range -10...+60mV. Default setting 0...20mV. Minimum measuring range 2mV.

HD978TR6: Configurable signal converter amplifier with 0...10Vdc (10...0Vdc) output. Input measuring range -10...+60mV. Default setting 0...20mV. Minimum measuring range 2mV.

LPPHOT01S

Transmitter with MODBUS-RTU RS485 output for the probe LPPHOT01

The transmitter LPPHOT01S converts the mV analog signal generated by the illumination probe LPPHOT01 into a digital signal suitable to be transmitted over a serial line RS485 with MODBUS-RTU protocol. All connections are made via screw terminals accessible by removing the top cover of the transmitter. The container is designed for wall mounting.

Technical specifications

Measuring range of the probe LPPHOT01	Low range: 0...10.000 lux (default) High Range: 0...200.000 lux
Resolution	1 lux (low range) / 10 lux (high range)
Output	RS485 (1 Unit Load) with MODBUS-RTU protocol, non isolated
Power supply	5...30 Vdc
Housing dimensions	80 x 84 x 44 mm
Protection degree	IP 66
Working Temperature / %RH	-30...+70 °C / 0...90% U.R. without condensation
Storage temperature	-40...+80 °C

Setting the RS485 communication parameters of the transmitter

Before connecting the transmitter to the RS485 network, assign an address and set the communication parameters, if different from those preset by the factory. The parameter setting is done by connecting the transmitter to the PC via optional RS485, with integrated converter RS485/USB. In order to use the cable the USB drivers should be installed on your PC. Alternatively, instead of the cable RS485, it is possible to use a generic RS485/RS232 or RS485/USB converter.

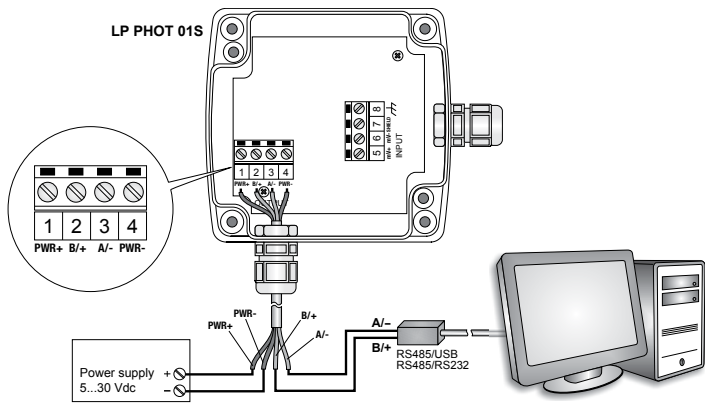

Procedure for setting the parameters.

- The transmitter should be powered off.
- Start a program of serial communication standards, such as Hyperterminal, set the number of the COM port to which the transmitter should be connected, set the Baud Rate to 57600 and the communication parameters as follows:
Data bits: 8 Parity: None Stop bits: 2
- Power the transmitter on and wait for the reception of the character &, then send (within 10s from the instant the transmitter is powered on), the @ command and press the enter key.

Note: If the transmitter does not receive the @ command within 10 seconds since when powered, it automatically switches the RS485 MODBUS on. In this case, it is necessary to remove and restore power to the transmitter.

4. Send the command CAL USER ON.

Note: The command CAL USER ON turns off after 5 minutes of inactivity.

- Send the serial commands reported in the following table to set the parameters of RS485 MODBUS:

Command	Response	Description
CMA _{nnn}	&l	Set address RS485 a nnn Between 1 and 247 Preset to 1
CMB _n	&l	Set Baud Rate RS485 n=0 ⇒ 9600 n=1 ⇒ 19200 Preset to 1 ⇒ 19200

Command	Response	Description
CMP _n	&l	Sets transmission mode RS485 n=0 ⇒ 8-N-1 (8 data bit, no parity, 1 stop bit) n=1 ⇒ 8-N-2 (8 data bit, no parity, 2 stop bit) n=2 ⇒ 8-E-1 (8 data bit, even parity, 1 stop bit) n=3 ⇒ 8-E-2 (8 data bit, even parity, 2 stop bit) n=4 ⇒ 8-O-1 (8 data bit, odd parity, 1 stop bit) n=5 ⇒ 8-O-2 (8 data bit, odd parity, 2 stop bit) Preset to 2 ⇒ 8-E-1
CMW _n	&l	Sets receiving mode after RS485 transmission n=0 ⇒ Violates the protocol and goes in Rx mode right after Tx n=1 ⇒ Respects the protocol and waits 3.5 characters after Tx Preset on 1 ⇒ Respects the protocol

6. It is possible to check the parameter settings by sending the following commands:

Command	Response	Description
RMA	Address	Reads the RS485 address
RMB	Baud Rate	Reads RS485 Baud Rate 0 ⇒ 9600 1 ⇒ 19200
RMP	Tx Mode (0,1,2,3,4,5)	Reads RS485 transmission mode 0 ⇒ 8-N-1 1 ⇒ 8-N-2 2 ⇒ 8-E-1 3 ⇒ 8-E-2 4 ⇒ 8-O-1 5 ⇒ 8-O-2
RMW	Rx Mode (0,1)	Reads receiving mode after RS485 transmission 0 ⇒ Violates the protocol and goes in Rx mode right after Tx 1 ⇒ Respects the protocol and waits 3.5 characters after Tx

Connection diagram for the operating mode

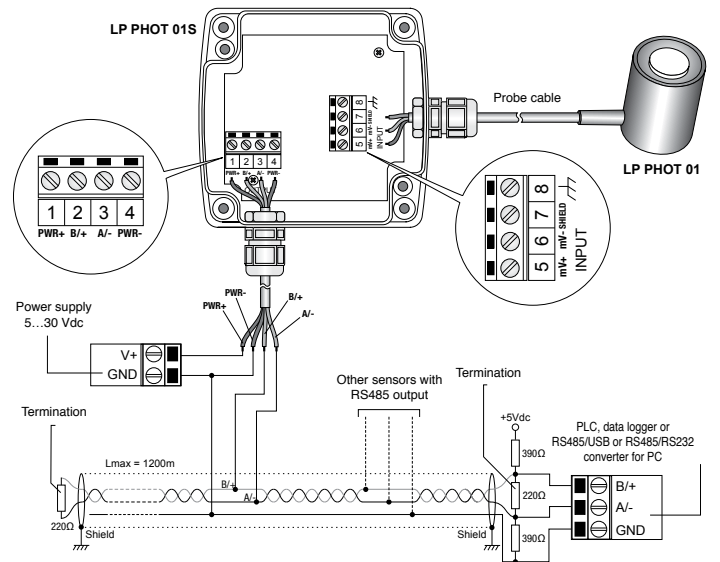

Terminal	Symbol	Function
1	PWR+	Positive Power Supply
2	B/+	RS485 B/+
3	A/-	RS485 A/-
4	PWR-	Negative Power Supply
5	mV+	Positive input signal in mV
6	mV-	Negative input signal in mV
7	SHIELD	Probe cable shield
8		Grounding

In order to get the maximum accuracy, it is recommended not to extend the shielded cable that came with the LPPHOT01. It is also recommended not to pass the wiring in the vicinity of power cables (motors, induction ovens, inverters, etc...).

In RS485 connection, the instruments are connected via a shielded twisted pair cable for signals and a third wire for grounding. At the two ends of the network must present the line terminations. To polarize the line during periods of non-transmission, use the resistors connected among the signal lines and the power supply.

The maximum number of devices connected to the line (Bus) RS485 depends on the load characteristics of the devices to be connected. The RS485 standard requires that the total load does not exceed 32 unit loads (Unit Loads). The load of a transmitter LPPHOT01S is equal to 1 unit load.

If the total load is greater than 32 unit loads, divide the network into segments and then put in a segment and the next a signal repeater. The beginning and end of each segment must be applied for line termination.

Operating mode

The transmitter enters the RS485 MODBUS-RTU mode after 10 seconds after turning on. During the first 10 seconds after turning on, the unit does not respond to any requests from the "master" MODBUS unit. After 10 seconds, it is possible to send requests to the transmitter MODBUS

Reading the measurements by using the MODBUS-RTU protocol

It is possible to read the measured values by the transmitter by using code function 04h (Read Input Registers). The following table lists the information available with the appropriate register address:

Address	Quantity	Format
2	Illuminance in lux (low range) or lux/10 (high range)	16 Integer
3	Status register bit 0 = 1 ⇒ measure illuminance in error bit 2 = 1 ⇒ error in the configuration data bit 3 = 1 ⇒ error in the program memory	16 Integer
4	Average illuminance in lux (low range) or lux/10 (high range) The average of the last 4 measurements	16 Integer
5	Value of the input signal in μV (low range) or $\mu\text{V}/10$ (high range)	16 Integer

Setting the sensitivity of the probe and the measurement range

The measuring range preset in the transmitter is 0...10,000 lux (low range), normally suitable for indoor measurements. If it has to be higher, for example in the case of outdoor measurements, it can be set to 0...200,000 lux (high range). The two ranges meet different resolutions: 1 lux for the low range, 10 lux for the high range.

The setting of the value of the probe sensitivity is required in case of replacement of the probe connected to the transmitter with a new probe with different sensitivity.

In order to set the sensitivity of the probe and the measurement range, proceed as follows:

1. Start when the transmitter is not powered.
2. Connect the transmitter to your PC via **optional RS48 cable**.
3. Start a standard serial communication program, such as Hyperterminal. Set the number of the COM port to which the transmitter has to be connected, set the Baud Rate to 57600 and communication parameters as follows:
Data Bits: 8
Parity: None
Stop bit: 2
4. Power the transmitter on and wait for the reception of the character **&**, then send (within 10 s from the instant the transmitter is powered on) the **@** command and press the **enter** key.
Note: If the transmitter does not receive the **@** command within 10 seconds since when powered, it automatically switches to the RS485 MODBUS. In this case it is necessary to remove and restore the power to the transmitter.
5. Send the command **CAL START**.
Note: The command CAL START turns off after 5 minutes of inactivity.
6. Send the following serial commands:

Command	Response	Description
CLSnnn	&l	Sets the sensitivity of the probe to the value nnn in $\mu\text{V}/\text{klux}$
02E	&l	Sets a low range (0...10.000 lux, resolution 1 lux)
02D	&l	Sets a high range (0...200.000 lux, resolution 10 lux)

7. It is possible to check the setting of the sensitivity of the probe and of the measurement range by sending the following commands:

Command	Response	Description
RLS	&nnnl	Reads the set sensitivity in $\mu\text{V}/\text{klux}$
RO	hhhl	Reads the configuration bite: bit 2 = 0 ⇒ high range (0...200.000 lux, resolution 10 lux) bit 2 = 1 ⇒ low range (0...10.000 lux, resolution 1 lux) <i>the bit 2 is the third bit from the right of the configuration byte</i>

Note: the reading of the settings with the controls and RLS and RO does not require sending the command CAL START.

At the end of the settings, turn off and on the transmitter to activate the operating mode RS485 MODBUS-RTU.

Dimensions

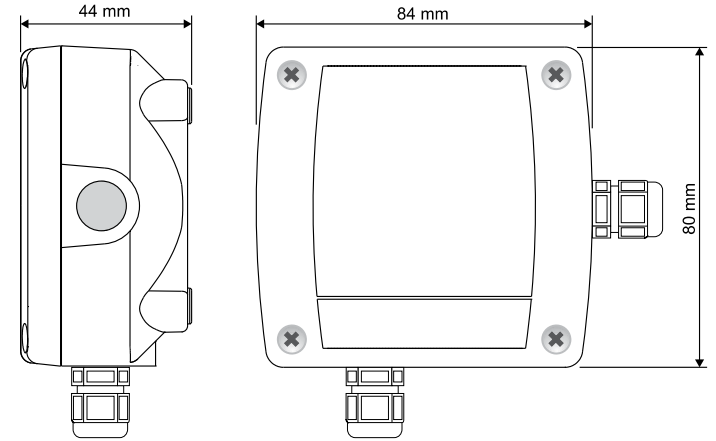

ORDERING CODES:

LPPHOT01S: Transmitter with RS485 MODBUS-RTU for the illumination probe LPPHOT01. Measuring range: 0...10,000 lux with resolution 1 lux or 0...200,000 lux with resolution 10 lux. Connections with screw terminals. Housing for wall mounting. Power supply 5...30 Vdc. Equipped with illumination probe LPPHOT01.

RS48: Connecting cable to PC for the configuration of the MODBUS parameters. Equipped with integrated converter RS485/USB. Free leads from the instrument, USB type A connector on the PC side.



**LPPHOT03 - LPRAD03 - LPPAR03 - LPUVA03 - LPUVB03
PHOTOMETRIC AND RADIOMETRIC PROBES WITH OUTPUT SIGNAL IN mV
OR NORMALIZED 4...20mA OR 0...10Vdc OR RS485 MODBUS-RTU OUTPUT**

Photo-radiometric probes with output signal in mV or standard output 4...20mA or 0...10Vdc or RS485 MODBUS-RTU output. The probes of the series LP...03 for outdoor use allow to measure photometric and radiometric quantities such as: illuminance (lux), irradiance (W/m²) in the near ultraviolet spectral region VIS-NIR, UVA, UVB, and the photon flow across the PAR region (400nm...700nm). The probes with mV output do not require any power supply. The output signal is obtained from a resistance that short-circuits the terminal of the photodiode. The ratio of generated photocurrent to incident light power is converted into a Difference of Potential that can be read by a voltmeter. Once the DDP (Difference of Potential) is known, the measured value can be calculated through the calibration factor. **All probes are individually calibrated and the calibration factor is also shown on the probe housing.** The probes with normalized output current 4...20mA or voltage 0...10Vdc or RS485 MODBUS RTU output require external power supply. The probe LPUVB03 is available only with standard output voltage 0...5Vdc and requires external power supply. All probes of the series LP...03 are equipped with diffuser for cosine correction and protection dome. **M12 male 4-pole connector (M12 8-pole connector for the LPUVB03).** Cables with female connectors and with 2, 5 or 10m length available on request.

LPPHOT03

The probe LPPHOT03 measures illuminance (lux), defined as the ratio between the luminous flux (lumen) passing through a surface and the surface area (m²). The spectral response curve of a photometric probe is similar to the human eye curve, known as standard photopic curve V(λ). The difference in spectral response between LPPHOT03 and the standard photopic curve V(λ) is calculated by means of the error f₁. Calibration is carried out by comparison with a reference luxmeter, calibrated by a Primary Metrological Laboratory. The Calibration Procedure complies with the CEI publication No.69 "Methods of characterizing illuminance meters and luminance meters: Performance characteristics and specifications, 1987". The photometric measurement probe is designed for outdoor readings. CIE photopic filter. Output, according to the chosen configuration, in mV or 4...20mA or 0...10Vdc normalized output or RS485 MODBUS-RTU output.

TECHNICAL SPECIFICATIONS:

Typical sensitivity:	0.5...1.5 mV/(klux)
Spectral range:	V(λ)
Calibration uncertainty:	< 4%
f ₁ (agreement with the standard curve V(λ)):	<6%
f ₂ (Cosine response)	<3%
f ₃ (linearity)	<1%
Operating temperature:	-20°C...+60°C
Impedance:	0.5...1.0 kΩ non-normalized version
Version with normalized output 4...20mA:	4mA = 0 klux, 20mA = 150 klux
Version with normalized output 0...10Vdc	0V = 0 klux, 10V = 150klux
Version with RS485 MODBUS-RTU output:	0...150klux

Power supply:	10...30Vdc for version with normalized output 4...20mA
	15...30Vdc for version with normalized output 0...10Vdc
	5...30Vdc for version with RS485 MODBUS-RTU output

Typical spectral response curve of LPPHOT03:

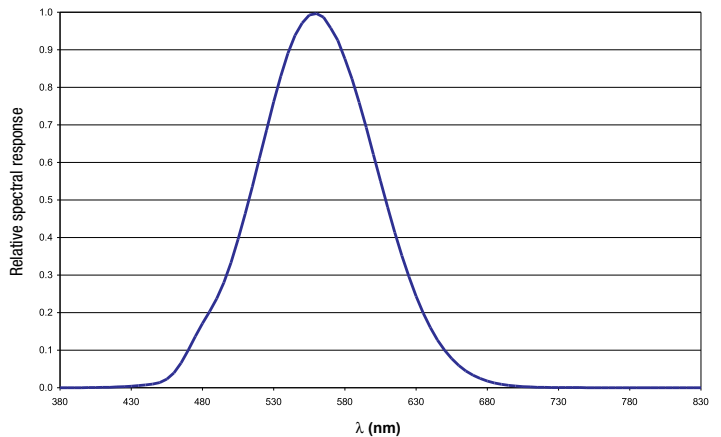

ORDERING CODES:

LPPHOT03: Photometric probe for the measurement of illuminance, complete with diffuser and glass dome, silica gel cartridge, female 4-pole connector, calibration report. **Cable with female connector has to be ordered separately.** Cables: CPM12AA4... (except LPPHOT03BLS) or CPM12-8D... (only LPPHOT03BLS) with cable length 2, 5 or 10 meters.

LPPHOT	<input type="checkbox"/>	03 = mV / klux 03BL = mV / klux output, base with levelling device 03BLAC = base with levelling device output 4...20 mA 03BLAV = base with levelling device output 0...10 V 03BLS = RS485 MODBUS-RTU output, base with levelling device
--------	--------------------------	---

CABLE:	<input type="checkbox"/>	2 = length 2m 5 = length 5m 10 = length 10m
--------	--------------------------	---

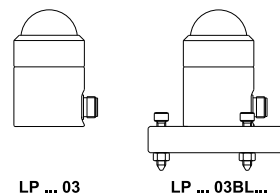

LPRAD03

LPRAD03 probe measures irradiance (W/m^2) defined as the ratio between the radiant flux (W) passing through a surface and the surface area (m^2) in the VIS-NIR (400nm- 1050nm) spectral range. The probe is designed **for outdoor readings**.

Output, according to the chosen configuration, in μV per $\mu W/cm^2$ or 4...20mA or 0...10Vdc normalized output or RS485 MODBUS-RTU output.

TECHNICAL SPECIFICATIONS

Typical sensitivity:	1...2.5 $\mu V/(\mu W/cm^2)$
Spectral range:	400nm...1050nm
Calibration uncertainty:	<5%
f_2 (cosine response):	<3%
f_3 (linearity)	<1%
Operating temperature:	-20°C...+60°C
Impedance:	0.5...1.0 k Ω (non-normalized version)

Version with normalized output 4...20mA:	4mA = 0 W/m^2 , 20mA = 2000 W/m^2
Version with normalized output 0...10Vdc	0V = 0 W/m^2 , 10V = 2000 W/m^2
Version with RS485 MODBUS-RTU output:	0... 2000 W/m^2

Power supply:	10...30Vdc for version with normalized output 4...20mA
	15...30Vdc for version with normalized output 0...10Vdc
	5...30Vdc for version with RS485 MODBUS-RTU output

Typical spectral response curve **LPRAD03**

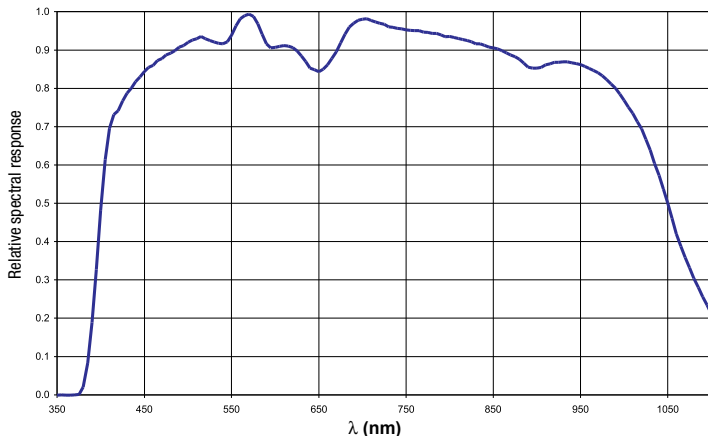

ORDERING CODES:

LPRAD03: Radiometric probe for the measurement of irradiance, complete with diffuser and glass dome, silica gel cartridge, 4-pole connector. Cable with female connector has to be ordered separately. Cables: **CPM12AA4**...(except LPRAD03BLS) or **CPM12-8D**...(only LPRAD03BLS) with cable length 2, 5 or 10 meters.

LPRAD	03 = $\mu V/(\mu W/cm^2)$ output 03BL = $\mu V/(\mu W/cm^2)$ output, base with levelling device 03BLAC = base with levelling device output 4...20 mA 03BLAV = base with levelling device output 0...10 V 03BLS = RS485 MODBUS-RTU output, base with levelling device
--------------	---

CABLE:	
CPM12AA4.	2 = length 2m
CPM12-8D.	5 = length 5m
	10 = length 10m

LPPAR03

The probe LPPAR03 measures the ratio between the number of photons that strike a surface in one second, in the 400nm...700nm spectral range and the surface area (m^2).

This quantity is defined as PAR: Photo-synthetically Active Radiation.

The probe calibration is carried out by using an halogen lamp, with a known spectral irradiance in a specific spectral range. Temperature slightly affects the probe spectral response.

The probe is **designed for outdoor readings**. Output, according to the chosen configuration, in $\mu V/(\mu mol(m^{-2}s^{-1}))$ or 4...20mA or 0...10Vdc normalized output or RS485 MODBUS-RTU output.

TECHNICAL SPECIFICATIONS

Typical sensitivity:	1...2.5 $\mu V/(\mu mol(m^{-2}s^{-1}))$
Typical spectral range:	400 nm...700 nm
Calibration uncertainty:	<5%
f_2 (cosine response):	<3%
f_3 (linearity)	<1%
Operating temperature:	-20°C...+60°C
Impedance:	0.5...1.0 k Ω non-normalized version

Version with normalized output 4...20mA:	4mA = 0 $\mu mol(m^{-2}s^{-1})$, 20mA = 5000 $\mu mol(m^{-2}s^{-1})$
Version with normalized output 0...10Vdc:	0V = $\mu mol(m^{-2}s^{-1})$, 10V = 5000 $\mu mol(m^{-2}s^{-1})$
Version with RS485 MODBUS-RTU output:	0... 5000 $\mu mol(m^{-2}s^{-1})$

Power supply:	10...30Vdc for version with normalized output 4...20mA
	15...30Vdc for version with normalized output 0...10Vdc
	5...30Vdc for version with RS485 MODBUS-RTU output

Typical spectral response curve **LPPAR03**

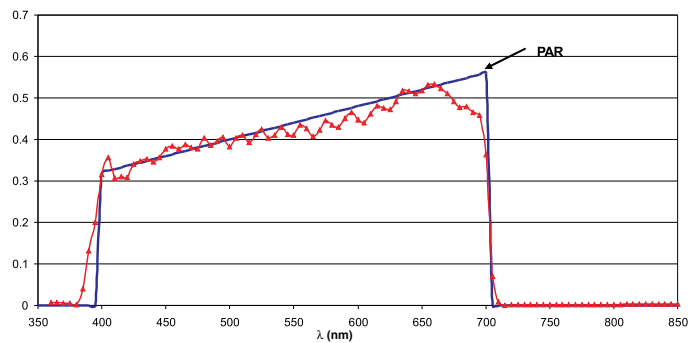

ORDERING CODES:

LPPAR03 Radiometric probe for the measurement of the Photon flux in the PAR action spectra, complete with diffuser and glass dome, silica gel cartridge, 4-pole connector. **Cable with female connector has to be ordered separately**. Cables: **CPM12AA4**...(except LPPAR03BLS) or **CPM12-8D**...(only LPPAR03BLS) with cable length 2, 5 or 10 meters.

LPPAR	03 = $\mu V/(\mu mol m^{-2}s^{-1})$ output 03BL = $\mu V/(\mu mol m^{-2}s^{-1})$ output, base with levelling device 03BLAC = base with levelling device, output 4...20 mA 03BLAV = base with levelling device, output 0...10 V 03BLS = RS485 MODBUS-RTU output, base with levelling device
--------------	---

CABLE:	
CPM12AA4	2 = length 2m
CPM12-8D.	5 = length 5m
	10 = length 10m

LPUVA03

The LPUVA03 probe measures irradiance (W/m^2) defined as the ratio between the radiant flux (W) passing through a surface and the surface area (m^2) in the UVA (315 nm...400 nm) spectral range. Thanks to a new type of photodiode, LPUVA03 is blind to visible and infrared light.

Probe calibration is carried out by using a 365 nm line of a Xe-Hg, filtered through a special interferential filter. Measurement is carried out by comparison with the primary standards, assigned to Delta OHM Metrological Laboratory. The probe is designed for **outdoor readings**. Output, according to the chosen configuration, in μV per $\mu W/cm^2$ or 4...20mA or 0...10Vdc normalized output or RS485 MODBUS-RTU output.

TECHNICAL SPECIFICATIONS

Typical sensitivity:	70...200 $\mu V/(W/m^2)$
Measuring range:	327...384nm (1/2)
	312...393nm (1/10)
	305...400nm (1/100)
	Peak: 365nm
Calibration uncertainty:	<6%
f_2 (cosine response):	<6%
f_3 (linearity):	<1%
Operating temperature:	-20°C...+60°C
Impedance:	0.5...1.0 k Ω non-normalized version

Version with normalized output 4...20mA:	4mA = 0 W/m^2 , 20mA = 2000 W/m^2
Version with normalized output 0...10Vdc:	0V = 0 W/m^2 , 10V = 2000 W/m^2
Version with RS485 MODBUS-RTU output:	0... 200 W/m^2

Power supply:	10...30Vdc for version with normalized output 4...20mA
	15...30Vdc for version with normalized output 0...10Vdc
	5...30Vdc for version with RS485 MODBUS-RTU output

Typical spectral response curve LPUVA03:

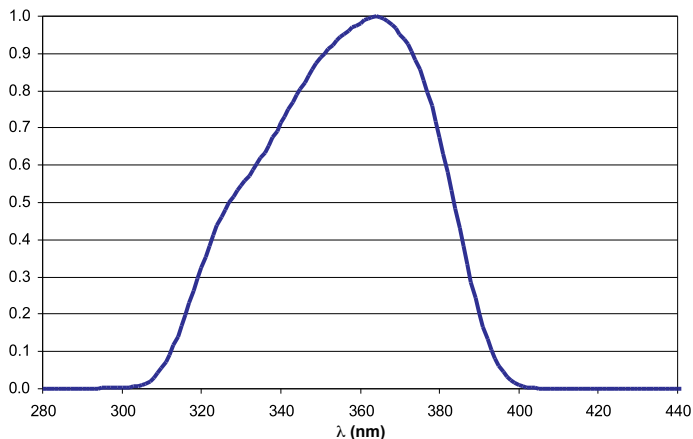

ORDERING CODES:

LPUVA03: Radiometric probe for the measurement of the UVA irradiance, complete with K5 dome, silica gel cartridge, 4-pole connector. **Cable with female connector has to be ordered separately.** Cables: **CPM12AA4**... (except LPUVA03BLS) or **CPM12-8D**... (only LPUVA03BLS) with cable length 2, 5 or 10 meters

LPUVA	<input type="checkbox"/>	03 = $\mu V/(\mu W/cm^2)$ output
	<input type="checkbox"/>	03BL = $\mu V/(\mu W/cm^2)$ output, base with levelling device
	<input type="checkbox"/>	03BLAC = base with levelling device output 4...20 mA
	<input type="checkbox"/>	03BLAV = base with levelling device output 0...10 V
	<input type="checkbox"/>	03BLS = RS485 MODBUS-RTU output, base with levelling device

CABLE:		
CPM12AA4 ,	<input type="checkbox"/>	2 = length 2m
CPM12-8D ,	<input type="checkbox"/>	5 = length 5m
	<input type="checkbox"/>	10 = length 10m

P UVB03BLAV

The LPUVB03BLAV probe measures global irradiance (W/m^2) on a surface area (m^2) in the UVB (280 nm...315 nm) spectral region. In particular, the spectral sensitivity is focused at 305 nm, with a bandwidth (FWHM) of 5nm. The global irradiance is the result of the sum of direct solar irradiance and of diffused irradiance incident on a planar surface. In the UVB spectral region, unlike in the visible portion where the direct component prevails over the direct component, the light is strongly diffused by the atmosphere and thus the two components are equivalent, therefore is very important that the instrument is capable of measuring accurately both the components. The probe is designed for **outdoor readings**.

Typical output 0...5Vdc.

TECHNICAL SPECIFICATIONS

Typical sensitivity:	$\approx 6V/(W/m^2)$
Typical spectral range:	301nm...306nm (1/2)
	295...308.5nm (1/10)
	290...311.5nm (1/100)
	Peak at 304nm
Calibration uncertainty:	<6%
f_2 (cosine response):	<6%
f_3 (linearity):	<1%
Working temperature:	-20...+60°C
Output:	0...1 W/m^2
Power supply:	15...30Vdc

Typical spectral response curve LPUVB03BLAV

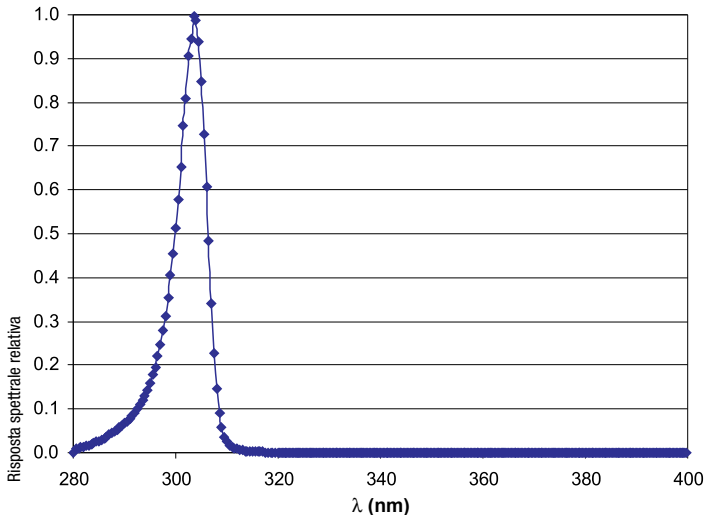

ORDERING CODES:

LPUVB03BLAV: Radiometric probe for the measurement of the UVB irradiance, complete with Quartz dome, 3 silica gel cartridges, 8-pole M12 connector, calibration report. **Cable with female connector has to be ordered separately.** Cables: **CPM12AA8** ..., with cable lengths 2, 5 or 10 meters.

LPUVB	<input type="checkbox"/>	03BLAV = 0...5 V, complete with levelling device
-------	--------------------------	---

CABLE:		
CPM12AA8 ,	<input type="checkbox"/>	2 = length 2m
	<input type="checkbox"/>	5 = length 5m
	<input type="checkbox"/>	10 = length 10m

WIRING DIAGRAM
4-pole wire CPM12AA4...

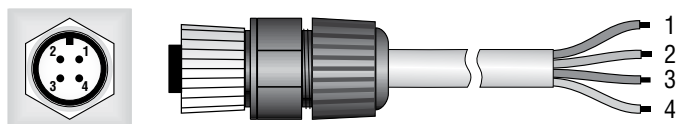

Fixed 4-pole plug M12 Flying 4-pole M12 connector

LPPHOT03, LPPHOT03BL
LPRAD03, LPRAD03BL
LPPAR03, LPPAR03BL
LPUVA03, LPUVA03BL

Connector	Function	Color
1	Positive (+)	Red
2	Negative (-)	Blue
3	Not connected	White
4	Shield	Black

LPPHOT03BLAV
LPRAD03BLAV
LPPAR03BLAV
LPUVA03BLAV

Connector	Function	Color
1	(+) Vout	Red
2	(-) Vout and (-) Vdc	Blue
3	(+) Vdc	White
4	Shield	Black

LPPHOT03BLAC
LPRAD03BLAC
LPPAR03BLAC
LPUVA03BLAC

Connector	Function	Color
1	Positive (+)	Red
2	Negative (-)	Blue
3	Not connected	White
4	Shield	Black

8-pole wire CPM12-8D...

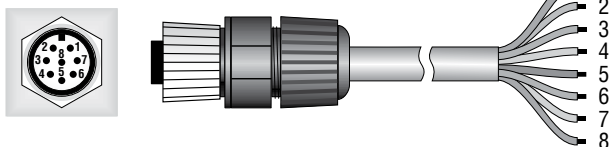

Fixed 8-pole plug M12 Flying 8-pole M12 socket

LPPHOT03BLS
LPRAD03BLS
LPPAR03BLS
LPUVA03BLS

Connector	Function	Color
1	Power supply negative (-)	Blue
2	Power supply positive (+)	Red
3	Not connected	
4	RS485 A/-	Brown
5	RS485 B/+	White
6	Housing	Shield (Black)
7	not connected	
8	not connected	

8-pole wire CPM12AA8...

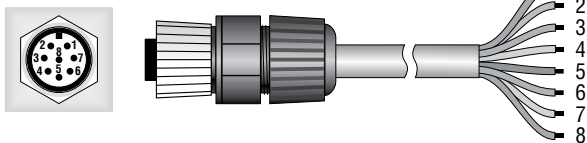

Fixed 8-pole plug M12 Flying 8-pole M12 socket

LPUVB03BLAV

Connector	Function	Color
1	Signal GND	Red
2	Vout UV (+)	Blue
3	Not connected	
4	Shield	Braid
5	Power GND (-)	Brown
6	Vout Temp. (+)	White
7	Housing	Black
8	Power (+) 7...30Vdc	Green

Address	Quantity	Format
2	LPPHOT03 : low range (20,000 lux) ^(*) : illuminance in lux LPPHOT03 : high range (200,000 lux) ^(*) : illuminance in lux/10 (e.g.: 3278 means 32780 lux, the resolution is 10 lux) LPRAD03 : irradiance in W/m ² LPPAR03 : photon flow in μmol m ⁻² s ⁻¹ LPUVA03 : UVA irradiance in W/m ² x 10 (e.g.: 425 means 42.5 W/m ² , the resolution is 0.1 W/m ²)	16-bit integer
3	Status register bit 0 = 1 measurement error bit 2 = 1 configuration data error bit 3 = 1 program memory error	16-bit integer
4	Average value of the last 4 measures	16-bit integer
5	LPPHOT03 : low range (20,000 lux) ^(*) : sensor signal in μV LPPHOT03 : high range (200,000 lux) ^(*) : sensor signal in μV/10 (e.g.: 3278 means 32780 μV, the resolution is 10 μV) LPRAD03 : sensor signal in μV/10 (e.g.: 9065 means 90650 μV, the resolution is 10 μV) LPPAR03 : sensor signal in μV LPUVA03 : sensor signal in μV	16-bit integer

(*) In the LPPHOT03BLS probe, the low or high range can be selected with a serial command. The setting procedure is provided in the probe operating manual

ACCESSORIES

CPM12AA4.2: Cable with 4-pole M12 connector on one end, open wires on the other side. Length 2m.

CPM12AA4.5: Cable with 4-pole M12 connector on one end, open wires on the other side. Length 5m.

CPM12AA4.10: Cable with 4-pole M12 connector on one end, open wires on the other side. Length 10m.

CPM12AA8.2: Cable with 8-pole M12 connector on one end, open wires on the other side. Length 2m. For LPUVB03LAV.

CPM12AA8.5: Cable with 8-pole M12 connector on one end, open wires on the other side. Length 5m. For LPUVB03LAV.

CPM12AA8.10: Cable with 8-pole M12 connector on one end, open wires on the other side. Length 10m. For LPUVB03LAV.

CPM12-8D.2: Cable with 8-pole M12 connector on one end, open wires on the other side. Length 2m. For probes with RS485 MODBUS-RTU output.

CPM12-8D.5: Cable with 8-pole M12 connector on one end, open wires on the other side. Length 5m. For probes with RS485 MODBUS-RTU output.

CPM12-8D.10: Cable with 8-pole M12 connector on one end, open wires on the other side. Length 10m. For probes with RS485 MODBUS-RTU output.

HD978TR3: Configurable signal converter amplifier with 4...20mA (20...4mA) output. Input range -10 ...+60mVdc. Standard configuration 0...20mVdc. Minimum measuring range 2mVdc. 2- DIN modules for 35mm rail. Configurable with HD778 TCAL

HD978TR5: Configurable signal converter amplifier with 4...20mA (20...4mA) output. Input range -10 ...+60mVdc. Standard configuration 0...20mVdc. Minimum measuring range 2mVdc. Configurable with HD778 TCAL. Container for Wall Mount installation.

HD978TR4: Configurable signal converter amplifier with 0...10Vdc (10...0Vdc) output. Input range -10 ...+60mVdc. Standard configuration 0...20mVdc. Minimum measuring range 2mVdc. 2- DIN modules for 35mm rail. Configurable with HD778 TCAL

HD978TR6: Configurable signal converter amplifier with 0...10Vdc (10...0Vdc) output. Input range -10 ...+60mVdc. Standard configuration 0...20mVdc. Minimum measuring range 2mVdc. Configurable with HD778 TCAL. Container for Wall Mount installation.

HD778 TCAL: Voltage generator in the range -60mVdc...+60mVdc, controlled by PC through the RS232C serial port, DELTALOG-7 (downloadable from Delta OHM website) software for setting K, J, T, N thermocouple transmitters and HD978TR3, HD978TR4, HD978TR5, HD978TR6 converters.

LPPHOT02



LPPHOT02 - LPPHOT02AC - LPPHOT02AV PHOTOMETRIC PROBES

The LPPHOT02, LPPHOT02AC, and LPPHOT02AV probes measure illuminance (lux), defined as the ratio between the luminous flux (lumen) through a surface and the surface area (m^2). The spectral response curve of a photometric probe is equal to the human eye, known as standard photopic curve $V(\lambda)$. The difference in spectral response between LPPHOT02 and the standard photopic curve $V(\lambda)$ is calculated by means of the error f'_1 . **LPPHOT02 is designed and constructed for outdoor installation for long periods.** The photometric measurement for external use is used for the measurement of daylight in climatological and meteorological applications.

Working principle

LPPHOT02 probe is based on a solid state sensor, whose spectral response corrected by filters to fit the response of the human eye. The typical spectral response curve is shown in fig.1.

LPPHOT02 is provided with a 50 mm diameter transparent glass dome, in order to protect the

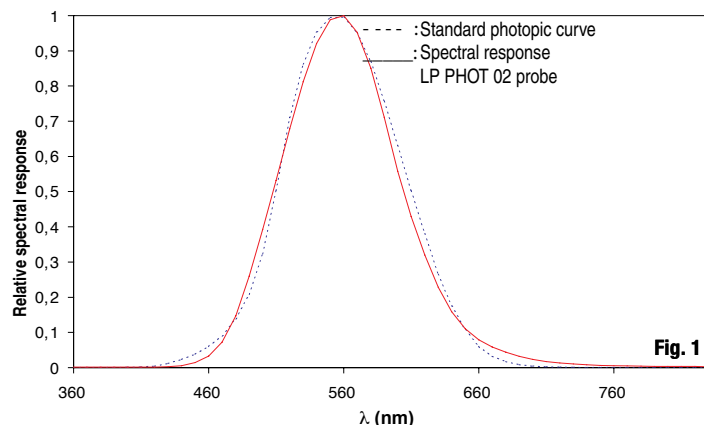

Fig. 1

sensor against atmospheric damage.

The cosine corrected response has been obtained through both the PTFE diffuser and case particular shapes. Deviation between the theoretical response and the real one, is shown in fig.2.

The LPPHOT02 excellent cosine response allows for use even when the sun elevation is low.

Installing and mounting the LPPHOT02 probe for global radiation measurements:

Before installation, the silica-gel cartridge must be refilled. Silica-gel crystals absorb humidity in the dome chamber and in case of particular climatic conditions, prevent internal condensation forming on the dome inner wall, with a consequent alteration in measurements. Do not wet or touch the instrument with your hands while refilling the silica-gel cartridge. Carry out the following instructions in a (possibly) dry environment:

- 1- Loosen the three screws that fix the white shade disk
- 2- Unscrew the silica-gel cartridge using a coin
- 3- Remove the cartridge perforated cap
- 4- Open the silica-gel sachet (supplied with the luxmeter)
- 5- Fill the cartridge with silica-gel crystals
- 6- Close the cartridge with its own cap, and check that the sealing O-Ring is in the right position.
- 7- Screw the cartridge to the luxmeter using a coin
- 8- Make sure the cartridge is tightly screwed (otherwise silica-gel crystal will last for a shorter time)
- 9- Position the shade and tighten it with the screws
- 10- The luxmeter is ready for use

Fig.3 shows the operations needed to refill the cartridge with silica-gel crystals

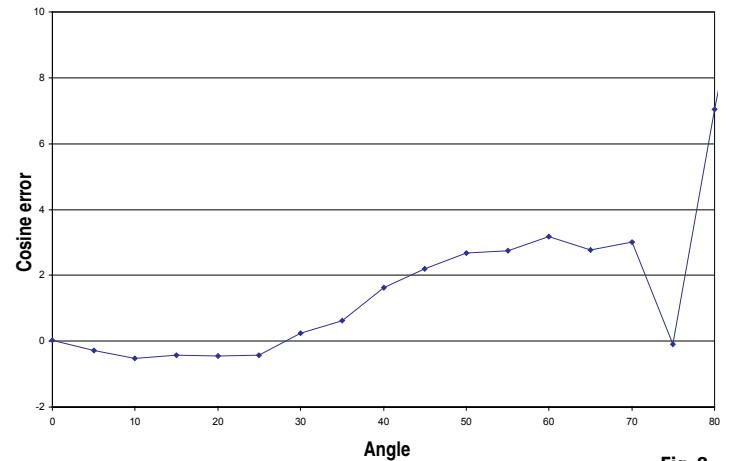

Fig. 2

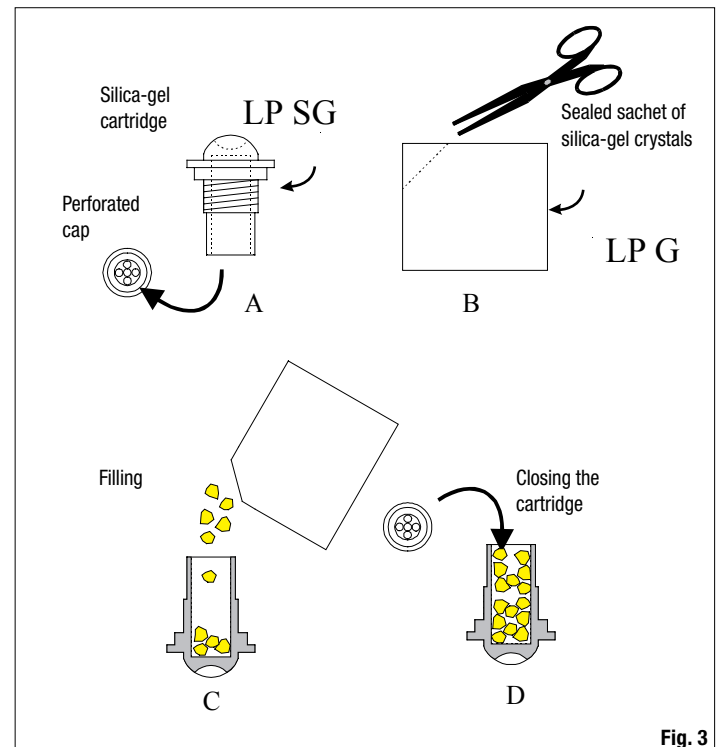

Fig. 3

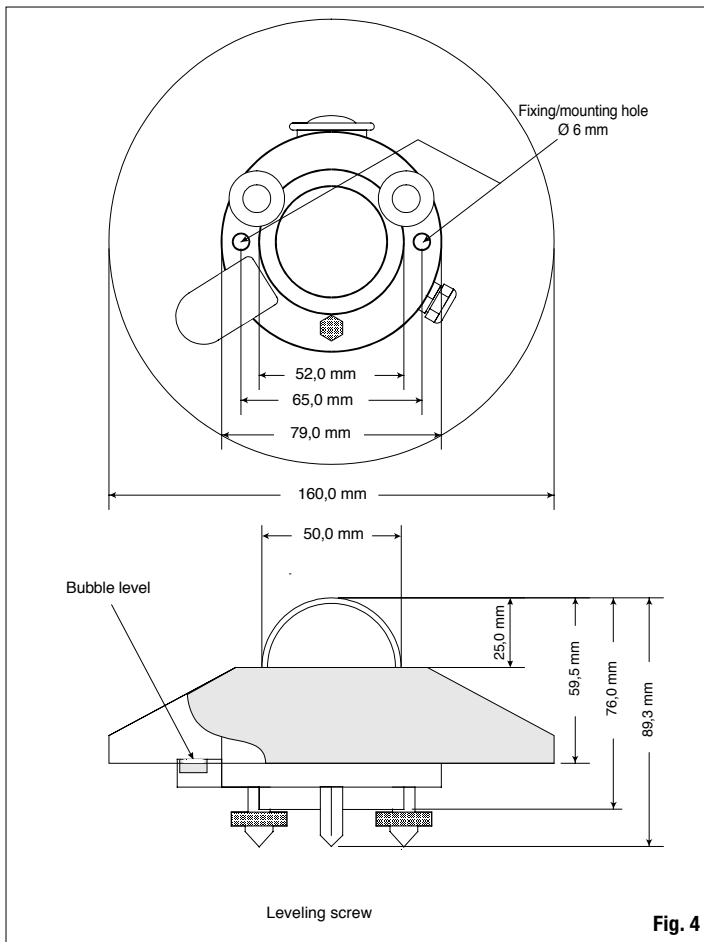
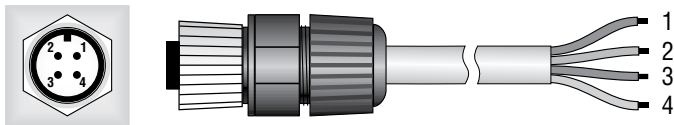

Fig. 4

WIRING DIAGRAM LPPHOT02



Fixed 4-pole plug M12

Flying 4-pole M12 connector

LPPHOT02

Connector	Function	Color
1	V out (+)	Red
2	V out (-)	Blue
3	Not connected	White
4	Shield (⊥)	Black

LPPHOT02 AC

Connector	Function	Color
1	Positive (+), +Vdc	Red
2	Negative (-), -Vdc	Blue
3	Not connected	White
4	Shield (⊥)	Black

LPPHOT02 AV

Connector	Function	Color
1	(+) Vout	Red
2	(-) Vout e (-) Vdc	Blue
3	(+) Vdc	White
4	Shield (⊥)	Black

- To allow cleaning the outer dome regularly and carrying out the instrument maintenance, LPPHOT02 should be mounted in easily reachable places. At the same time, you should check that no building, tree, or any other obstacle exceeds the horizontal plane where the luxmeter is mounted. In case this is not possible, you should find a place where obstacles do not exceed 5 degrees elevation over the path followed by the sun from rising until sunset.
- The luxmeter should be located far from any obstacle which might reflect sunlight (or any shadow) onto the instrument.



- For a correct horizontal placing, LPPHOT02 is provided with a bubble level; inclination adjustment of the luxmeter is made by means of two leveling screws. Use the two 6mm-diameter screw holes with an interaxial distance of 65 mm, to mount the instrument on a plane. To access the holes, remove the shade disk and reposition it after mounting (see fig. 4).
- LPS1 mounting kit is supplied upon demand as an accessory, and allows for an easy mounting of the instrument on a mast. The mast maximum diameter shall not exceed 50 mm. The operator will check that the mast height does not exceed the luxmeter plane, in order to avoid measurement errors due to any reflection or shadow of the mast itself. To fix the luxmeter to the mounting bracket, remove the shade disk by loosening the three screws, then fix the luxmeter to the bracket and mount the white shade disk again.
- The luxmeter should be thermally isolated from the mounting bracket, and the electrical contact with the ground must be properly made.

LPPHOT02 Electrical Connections and requirements for electronic readout devices

- LPPHOT02 luxmeter is passive and it does not require any power supply.
- LPPHOT02 is supplied with a flying 4-pole M12 connector
- UV-proof cables are available already assembled, with standard length 2m, 5m or 10m.
- Amplified probes are available, with current output signal 4...20mA or voltage output 0...1Vdc, 0...5Vdc or 0...10Vdc.

WIRING DIAGRAM CONNECTION

LPPHOT02

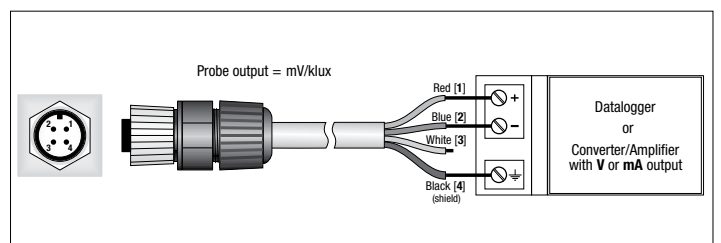

LPPHOT02 AC

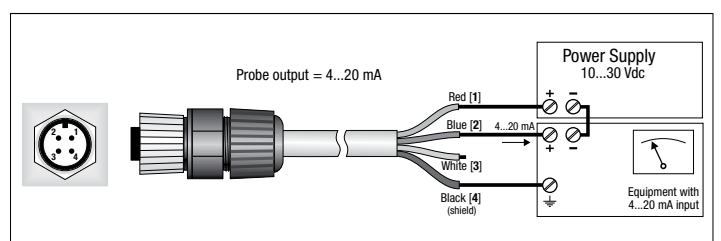

LPPHOT02 AV

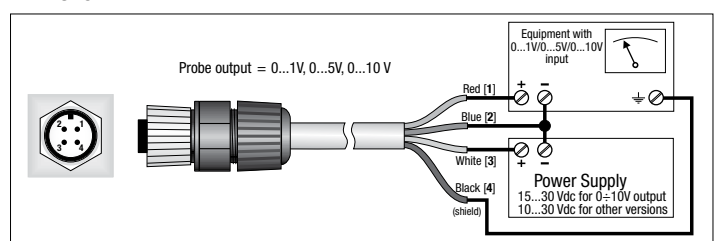

- The **optional** cable is UV-proof, cable colors and connector poles are matched as follows:
 Black → shield braid
 Red → (+) signal generated by the detector
 Blue → (-) negative signal generated by the detector (in contact with the housing)
 See wiring scheme.
- LPPHOT02 is to be connected to a millivoltmeter or data acquisition unit which input load resistance must be > 100kΩ.

Maintenance:

In order to grant the best precision and accuracy in measurements, the outer dome must be always kept clean; the cleaner you keep the dome, the better the accuracy in measurements will be. Washing can be made with water and standard lens paper; in case this wouldn't work, use pure ETHIL alcohol. After using alcohol, the dome must be washed with water only. Sudden rise and fall in temperature throughout day and night, might cause condensation to appear on the luxmeter dome; in this case the performed reading is highly overestimated. To reduce condensation, the luxmeter is provided with a cartridge containing desiccant material, such as Silica-gel. Silica-gel efficiency decreases in time while absorbing humidity. Active silica-gel crystals are **yellow** colored, while they turn into **white** when they gradually loose power. To replace them, see instructions at paragraph installing and mounting the LPPHOT02. Silica-gel generally lasts from 2 to 6 months, depending on which climatic conditions you have and where the luxmeter works.

Calibration and measurements:

The Luxmeter sensitivity, indicated as **S** (or calibration factor), allows determining illuminance by measuring a signal in Volts at the probe ends. **S** factor is measured in **V/klux**.

- Once the difference of potential (DDP) has been measured at sensor ends, E_e illuminance is obtained through the following formula:

$$E_e = DDP/S$$

where;

- E_e : indicates Illuminance expressed in klux,
- DDP: indicates the difference of potential expressed in mV and measured by the multimeter,
- S: indicates the calibration factor expressed in mV/klux and shown on the luxmeter label (calibration factor is also mentioned in the calibration report).

Each probe is individually calibrated at the factory and is distinguished by its calibrator factor. Calibration is carried out by using a standard **illuminant A**, as indicated in CIE publication N°69 "Methods of characterizing illuminance meters and luminance meters: Performance, characteristics and specifications, 1987". Calibration is carried out by comparison with a reference luxmeter, assigned to Delta OHM Metrological Laboratory. To get the best performances from LPPHOT02, it is recommended to check calibration annually.

Technical specifications:

Typical sensitivity:	0,5...2,0 mV/klux
Response time:	<0.5 sec (95%)
Impedance:	0.5...1 kΩ
Measuring range:	0...150 klux
Viewing angle:	2π sr
Spectral range:	Standard photopic curve
Operating temperature:	-40°C...80°C
Error f ₁	<9 %
Cosine response/directional error:	< 8 % (between 0° and 80°)
Long term instability (1 year):	< ±3 %
Non-linearity:	<1 %
Temperature response	< 0.1%/°C
Weight:	0.90 Kg
Dimensions:	fig. 4

ORDERING CODES:

LPPHOT02: Photometric probe for outdoor **Illuminance** measurements (0...150klux), CIE photopic filter, diffuser for cosine correction, complete with LPSP1 protection and silica gel cartridge, bubble level, 4-pole M12 plug and Calibration Report. **Cable has to be ordered separately.**

LPPHOT02AC: Photometric probe for outdoor **Illuminance** measurements (0...150klux), CIE photopic filter, diffuser for cosine correction. **4...20mA output**, integrated transmitter amplifier. **Power supply 10...30Vdc**. Complete with LPSP1 protection and silica gel cartridge, bubble level, 4-pole M12 plug and Calibration Report. **2m, 5m or 10m cables with connectors available on request.**

LPPHOT02AV: Photometric probe for outdoor **Illuminance** measurements (0...150klux), CIE photopic filter, diffuser for cosine correction. **0...1Vdc, 0...5Vdc, 0...10Vdc output**, integrated transmitter amplifier. **Power supply 10...30Vdc (15...30Vdc for 0...10Vdc output)**. Complete with LPSP1 protection and silica gel cartridge, bubble level, 4-pole M12 plug and Calibration Report. **2m, 5m or 10m cables with connectors available on request.**

LPS1: Mounting kit for LPPHOT02: bracket for attachment to a mast, including fasteners and levelling screws.

LPSP1: UV resistant plastic shade disk (BASF LURAN S777K).

LPSPG: Desiccant sachet with silica gel crystals, complete with inner O-ring and cap.

LPG: Packet with 5 silica gel spare cartridge.

LPRING02: Base with levelling device and adjustable holder for mounting the LPPHOT02 in an inclined position.

LPS6: Kit for the installation of LPS6.1). The kit includes: 750 mm mast (HD2003.83.1), base fitting (LP S6.04), graduated support plate (LP S6.01), bracket for pyranometers (LP S6.03). On request, HD9007T29.1 bracket for HD9007 or HD32MTT.03.C

CPM12AA4.2: 4-pole cable. Length 2m. 4-pole M12 connector on one end, open wires on the other side.

CPM12AA4.5: 4-pole cable. Length 5m. 4-pole M12 connector on one end, open wires on the other side.

CPM12AA4.10: 4-pole cable. Length 10m. 4-pole M12 connector on one end, open wires on the other side

HD978TR3: **Configurable** signal converter amplifier with 4...20mA (20...4mA) output. Input range -10...+60mVdc. **Standard configuration 0...20mVdc**. Minimum measuring range 2mVdc. 2- DIN modules for 35mm rail. **Configurable with HD778 TCAL**

HD978TR5: **Configurable** signal converter amplifier with 4...20mA (20...4mA) output. Input range -10...+60mVdc. **Standard configuration 0...20mVdc**. Minimum measuring range 2mVdc. **Configurable with HD778 TCAL. Container for Wall Mount installation.**

HD978TR4: **Configurable** signal converter amplifier with 0...10Vdc (10...0Vdc) output. Input range -10...+60mVdc. **Standard configuration 0...20mVdc**. Minimum measuring range 2mVdc. 2- DIN modules for 35mm rail.. **Configurable with HD778 TCAL**

HD978TR6: **Configurable** signal converter amplifier with 0...10Vdc (10...0Vdc) output. Input range -10...+60mVdc. **Standard configuration 0...20mVdc**. Minimum measuring range 2mVdc. **Configurable with HD778 TCAL. Container for Wall Mount installation.**

HD778TCAL: **Voltage generator** in the range -60mVdc...+60mVdc, **controlled by PC through the RS232C serial port, DELTALOG-7** software for setting K, J, T, N thermocouple transmitters and HD978TR3, HD978TR4, HD978TR5, HD978TR6 converters.

LPPHOTS: Transmitter with RS485 MODBUS-RTU output for LPPHOT01, LPPHOT02 and LPPHOT03 photometric probes with output in mV. Connections via screw terminals. Wall mount installation. Power supply 5...30 Vdc. Dimensions: 80 x 84 x 44 mm. IP 66.

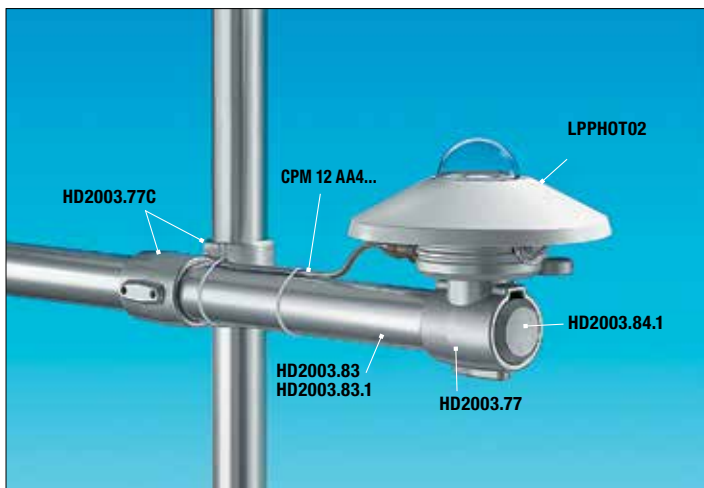

LPPHOT02

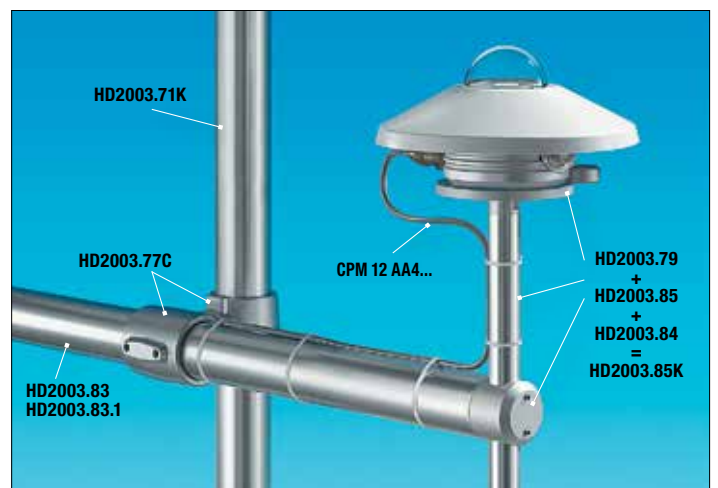

LPPHOT02

LPUVA02



LPUVA02 - LPUVA02AC - LPUVA02AV RADIOMETRIC PROBES

The radiometric LPUVA02, LPUVA02AC, and LPUVA02AV probes measure the global irradiance in the UVA on a flat surface (Watt/ m²). The irradiance is the sum of direct solar irradiance and of diffuse irradiance from the sky.

The radiometer can also be used for monitoring UVA irradiance indoor.

Working Principle

LPUVA02 radiometer is based on a solid state sensor, the spectral match with the desired curve is obtained using special filter. The relative spectral response is reported on figure 3. In order to protect the diffuser from the dust, LPUVA02 is equipped with a 50mm glass dome. The cosine law response is obtained with a particular shaped PTFE diffuser. In figure 4 the cosine error versus angle of incident is reported.

The excellent cosine law response of LPUVA02 allow to use the radiometer at any sun's zenith angle. (The diffused component of the UVA increases as the sun moves away from the zenith, so the error on direct component due to imperfect response according to the cosine becomes negligible on the measurement of global irradiance).

Installation and Mounting of the Radiometer for the Measurement of Global Radiation:

Before installation, refill the cartridge containing silica-gel crystals. Silica gel absorbs humidity in the dome chamber and prevents (in particular climatic conditions) internal condensation forming on the internal walls of the domes and measurement alteration.

Do not touch the silica gel crystals with your hands while refilling the cartridge. Carry out the following instructions in an environment as dry as possible:

- 1- Loosen the three screws that fix the white shade disk
- 2- Unscrew the silica gel cartridge using a coin
- 3- Remove the cartridge perforated cap
- 4- Open the sachet containing silica gel (supplied with the radiometer)
- 5- Replace the silica gel crystals
- 6- Close the cartridge with its own cap, paying attention that the sealing O-ring be properly positioned.
- 7- Screw the cartridge to the radiometer body using a coin
- 8- Check that the cartridge is screwed tightly (if not, silica gel life will be reduced)
- 9- Position the shade disk and screw it with the screws
- 10- The radiometer is ready for use.

Figure N.1 shows the operations necessary to fill the cartridge with the silica gel crystals.

- The LPUVA02 radiometer has to be mounted in a readily accessible location to clean the dome regularly and to carry out maintenance. At the same time, check that no building, construction, tree or obstruction exceeds the horizontal plane where the radiometer lays. If this is not possible, select a site where obstructions do not exceed 5 degrees of elevation, in the path followed by the sun, between earliest sunrise and latest sunset.
- The radiometer has to be located far from any kind of obstruction, which might reflect sunlight (or sun shadow) onto the radiometer itself.
- The LPUVA02 radiometer is provided with a spirit level for carrying out an accurate horizontal leveling. The adjustment is made by means of two leveling screws that allow to adjust the radiometer inclination. Use the two 6mm-diameter holes and a 65mm interaxial distance to mount the instrument on a plane. Remove the shade disk to access the holes and reposition it after mounting (see fig. 2).
- The LPS1 mounting kit, supplied on demand as an accessory, allows an easy mounting of the radiometer on a mast. The mast maximum diameter shall not exceed 50 mm. The operator shall take care that the mast height does not exceed the radiometer plane to avoid measurement errors caused by any reflection or shadow of the mast itself. To fix the radiometer to the mounting bracket, remove the shade disk loosening the three screws, fix the radiometer, and mount the white shade disk again.
- It is suggested to thermally isolate the radiometer from its mounting brackets, and to check that the electrical contact with the ground be done properly

Electrical Connection and Requirements for Electronic Readout Devices:

- LPUVA02 radiometer does not require any power supply.
- LPUVA02 is supplied with a 4-pole M12 connector
- UV-proof cables are **available on request**. Cable colors are as follows:
 - Black →shield braid
 - Red →(+) signal generated by the detector
 - Blue →(-) negative signal generated by the detector
- LPUVA02 is to be connected either to a millivoltmeter or data acquisition unit which input load resistance must be > 5MΩ. Typically, the radiometer output signal does not exceed 5...10mV. In order to better exploit the radiometer features, the readout instrument should have a 1μV resolution.

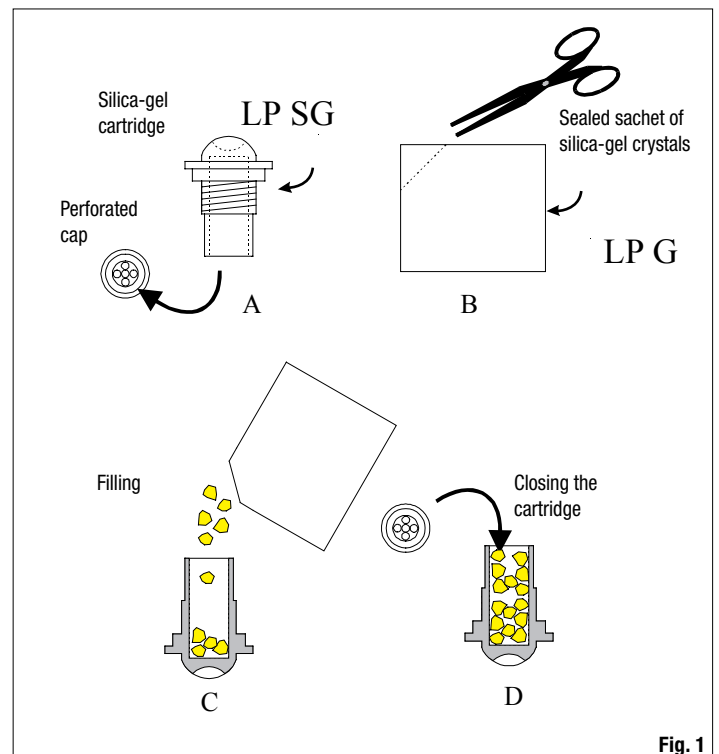
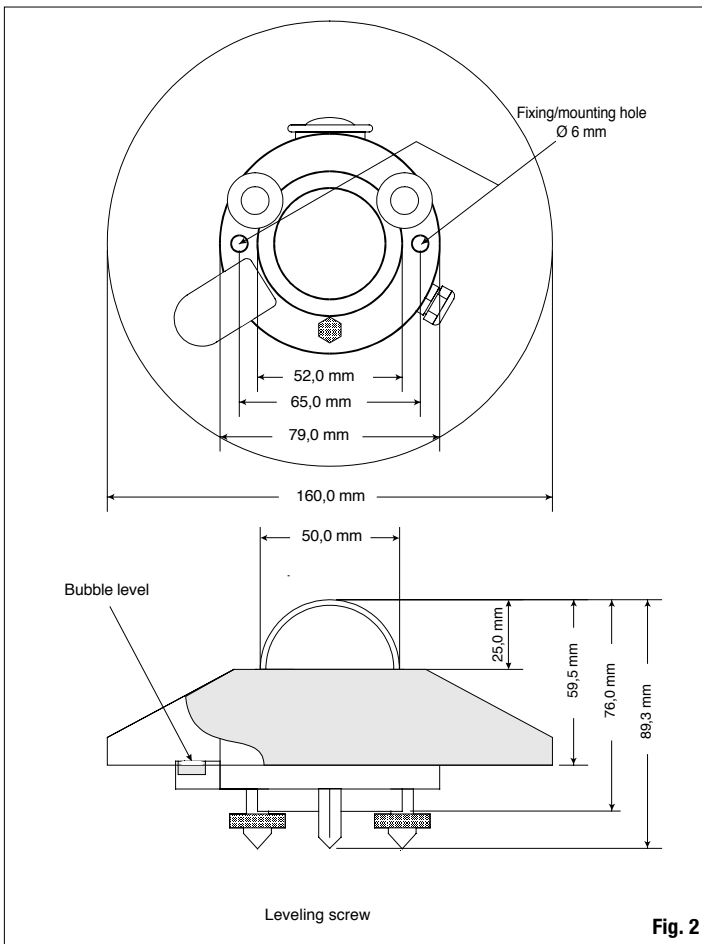

Fig. 1



active when their color is **yellow**, while they turn **white** as soon as they lose their power. Read instructions on how to replace them. Silica gel typical lifetime goes from 2 to 6 months depending on the environment where the radiometer works.

Calibration and Measurements:

The radiometer sensitivity **S** (or calibration factor) allows to determine the irradiance by measuring a signal in Volts at the ends of the resistance which short-circuits the terminals of the photodiode ends. The **S** factor is measured in $\mu\text{V}/(\text{W}/\text{m}^2)$.

- Once the difference of potential (DDP) has been measured at the ends of the sensor, the E_e irradiance is obtained applying the following formula:

$$E_e = \text{DDP}/S$$

Where:

E_e : is the Irradiance expressed in W/m^2 ,

DDP: is the difference of potential expressed in μV and measured by the multimeter,

S: is the calibration factor in $\mu\text{V}/(\text{W}/\text{m}^2)$ (shown on the radiometer label (and mentioned in the calibration report).

WIRING DIAGRAM LPUVA02

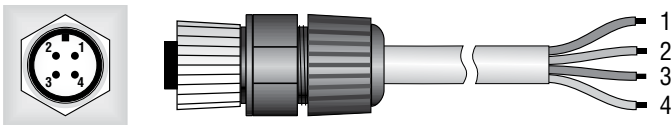

Fixed 4-pole plug M12

Flying 4-pole M12 connector

LPUVA02

Connector	Function	Color
1	V out (+)	Red
2	V out (-)	Blue
3	Not connected	White
4	Shield (\perp)	Black

LPUVA02 AC

Connector	Function	Color
1	Positive (+), +Vdc	Red
2	Negative (-), -Vdc	Blue
3	Not connected	White
4	Shield (\perp)	Black

LPUVA02 AV

Connector	Function	Color
1	(+) Vout	Red
2	(-) Vout e (-) Vdc	Blue
3	(+) Vdc	White
4	Shield (\perp)	Black

Maintenance:

It is important to keep the outer glass dome clean to grant measurement best accuracy. Consequently, the more the dome will be kept clean, the more measurements will be accurate. Washing can be made using water and standard papers for lens, or, in some cases, using pure ethyl alcohol. After using alcohol, clean again the dome with water only.

Because of the high rise/fall in temperature between day and night, some condensation might appear on the radiometer dome. To minimize the condensation growth, the radiometer is provided with a cartridge containing desiccant material: Silica gel. The efficiency of the Silica gel crystals decreases in the course of time while absorbing humidity. Silica gel crystals are

CONNECTION DIAGRAMS

LPUVA02

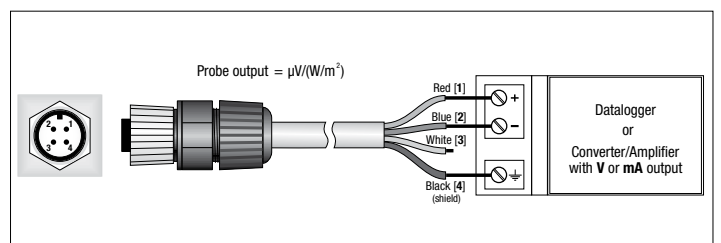

LPUVA02 AC

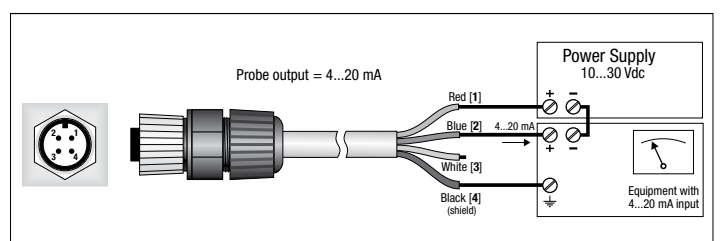

LPUVA02 AV

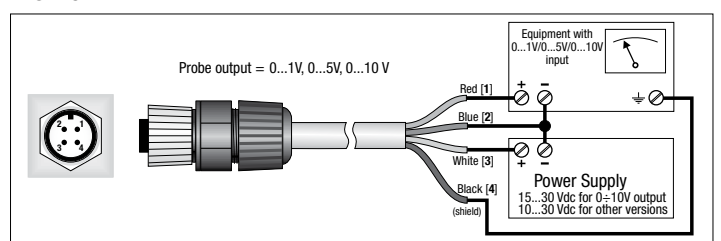

Each radiometer is individually calibrated at the factory and is distinguished by its calibrator factor.

The calibration is carried out following procedure N° DHLF-E-59. This procedure is used in the ACCREDIA LAT calibration center N° 124 for the calibration of UVA radiometers.

The calibration was performed by reference to Delta OHM srl primary standard with monochromatic light at 365 nm. To get best performances from your LPUVA02 it is strongly recommended that the calibration be checked annually.

Note: currently no international calibration standards for this type of radiometer exist; therefore, the calibration coefficient only makes sense if the procedure followed to obtain it has been specified. Therefore the user has to consider that the same radiometer calibrated with different procedures can have different sensitivity factors, as explained in the article "Source of Error in UV Radiation Measurements", T. C. Larason, C. L. Cromer issued in the "Journal of Research of the National Institute of Standards and Technology" Vol. 106, Num. 4, 2001. (The article is available free of charge on the NIST web site at the following address: <http://www.nist.gov/jers>)

Technical Specifications:

Typical sensitivity:	70...200µV/(W/m ²)
Response time	<0.5 sec (95%)
Impedance:	3 kΩ
Measuring range:	0...200 W/m ²
Viewing angle:	2π sr
Spectral range:	327 nm...384 nm (1/2) 312 nm...393 nm (1/10) 305 nm...400 nm (1/100)
Operating temperature	-40 °C...80 °C
Cosine response:	< 8 % (between 0° and 80°)
Long-term non-stability: (1 year)	< ±3 %
Non-linearity:	<1 %
Temperature response:	< 0.1%/°C
Dimensions:	figure 2
Weight:	0.90 Kg

ORDERING CODES:

LPUVA02: Radiometric probe for the outdoor measurement of UVA irradiance (315...400nm), complete with LPSP1 protection, silica gel cartridge, 2 spare sachets with silica gel crystals, bubble level, M12 4-pole connector and Calibration Report. **2m, 5m or 10m cables with connectors available on request.**

LPUVA02AC: Amplified radiometric probe for the outdoor measurement of UVA irradiance (315...400nm), **4...20mA output (0...200W/m²)**, integrated transmitter amplifier, **power supply 10...30Vdc**. Complete with M12 4-pole connector and Calibration Report. **2m, 5m or 10m cables with connectors available on request.**

LPUVA02AV: Amplified radiometric probe for the outdoor measurement of UVA irradiance (315...400nm), **0...1Vdc, 0...5Vdc, 0...10Vdc output (0...200W/m²)**, integrated transmitter amplifier, **power supply 10...30Vdc. (15...30Vdc for 0...10Vdc output)**. Complete with M12 4-pole connector and Calibration Report. **2m, 5m or 10m cables with connectors available on request.**

LPS1: Mounting kit for LPUVA02: bracket for attachment to a mast, including fasteners and leveling screws.

LPSP1: UV resistant plastic shade disk (BASF LURAN S777K).

LPSG: Desiccant sachet with silica gel crystals, complete with inner O-ring and cap.

LPG: Packet with 5 silica gel spare cartridge.

CPM12AA4.2: 4-pole cable. Length 2m. 4-pole M12 connector on one end, open wires on the other side. For LPUVA02, LPUVA02AC, LPUVA02AV.

CPM12AA4.5: 4-pole cable. Length 5m. 4-pole M12 connector on one end, open wires on the other side. For LPUVA02, LPUVA02AC, LPUVA02AV.

CPM12AA4.10: 4-pole cable. Length 10m. 4-pole M12 connector on one end, open wires on the other side For LPUVA02, LPUVA02AC, LPUVA02AV

LPRING02: Base with levelling device and adjustable holder for mounting the LPUVA02 in an inclined position.

LPS6: Kit for the installation of LPS6.1).The kit includes: 750 mm mast (HD2003.83.1), base fitting (LP S6.04), graduated support plate (LP S6.01), bracket for pyranometers (LP S6.03). On request,HD9007T29.1 bracket for HD9007 or HD32MTT.03.C

HD978TR3: Configurable signal converter amplifier with 4...20mA (20...4mA) output. Input range -10...+60mVdc. **Standard configuration 0...20mVdc.** Minimum measuring range 2mVdc. 2- DIN modules for 35mm rail. **Configurable with HD778 TCAL**

HD978TR5: Configurable signal converter amplifier with 4...20mA (20...4mA) output. Input range -10...+60mVdc. **Standard configuration 0...20mVdc.** Minimum measuring range 2mVdc. **Configurable with HD778 TCAL. Container for Wall mount installation.**

HD978TR4: Configurable signal converter amplifier with 0...10Vdc (10...0Vdc) output. Input range -10...+60mVdc. **Standard configuration 0...20mVdc.** Minimum measuring range 2mVdc. 2- DIN modules for 35mm rail. **Configurable with HD778 TCAL**

HD978TR6: Configurable signal converter amplifier with 0...10Vdc (10...0Vdc) output. Input range -10...+60mVdc. **Standard configuration 0...20mVdc.** Minimum measuring range 2mVdc. **Configurable with HD778 TCAL. Container for Wall mount installation.**

HD778TCAL: Voltage generator in the range -60mVdc...+60mVdc, **controlled by PC through the RS232C serial port, DELTALOG-7:** software for setting K, J, T, N thermocouple transmitters and HD978TR3, HD978TR4, HD978TR5, HD978TR6 converters.

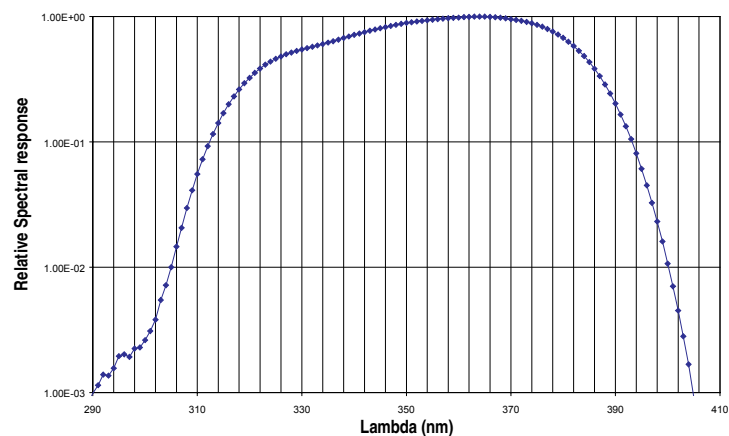
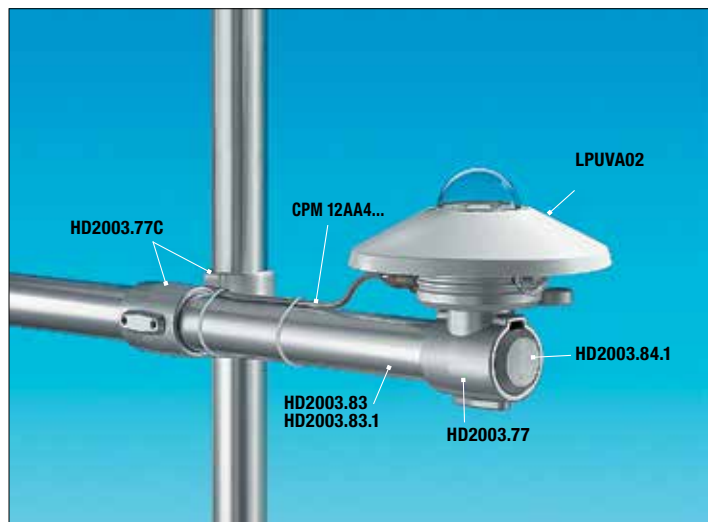

Fig. 3



LPUVA02

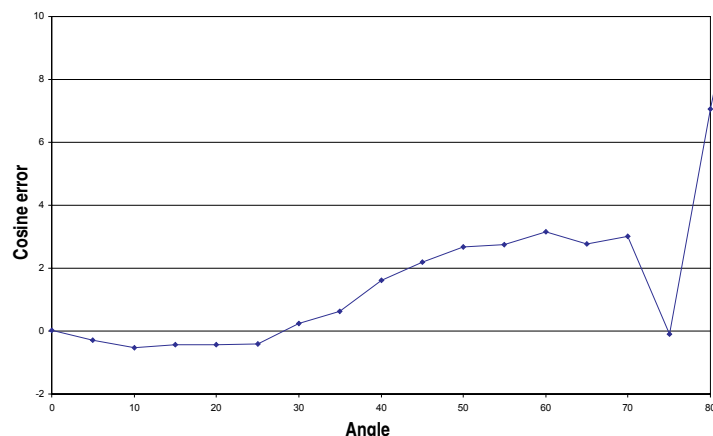

Fig. 4

LPUVB02



LPUVB02 RADIOMETRIC PROBE FOR ENVIRONMENTAL USE

The LPUVB02 radiometer measures the global irradiance in the UVB spectral region on a flat surface (Watt/m^2). In particular, the instrument's spectral sensitivity is centered at 305nm with a 5nm band width (FWHM). The global irradiance is the sum of the direct solar irradiance and the sky diffuse irradiance on a surface parallel to the ground. In contrast to the visible spectrum where the direct component prevails over the diffuse component, in the UVB spectral region light is strongly diffused by atmosphere and thus the two components are equivalent. Therefore it is of primary importance for the instrument to be capable of measure both components accurately.

The LPUVB02 probe is typically used in the following sectors:

- Monitoring the ozone layer. Indeed, the radiation around 295nm–315nm is strongly absorbed by ozone located in the stratosphere, therefore each small variation of the ozone layer corresponds to an increase or decrease of the radiation reaching the ground.
- Effects of UVB radiation (the most harmful to human health) on living beings.
- UVB radiation measurement in work spaces.

The LPUVB02 radiometer needs power to function. Power is required to amplify the weak signal generated by the photodiode. Indeed, the radiometer is a current/voltage amplifier (transimpedance amplifier). This choice measures sun-produced UVB irradiance. Indeed, the need to use sophisticated filters (partially attenuating the signal concerned) and the relatively weak sun-produced irradiation in this spectral area, in the best case, make the photodiode-generated current in the order of hundreds of pAmpere. So it is not possible to use cable meters or tens of meters long as the noise might be greater than the signal itself. Therefore the signal must be amplified.

LPUVB02 is robust and is manufactured to operate for long periods without maintenance (if powered correctly). This characteristic makes it suitable for location in meteorological stations. A platinum-resistance thermometer (Pt100) is inserted inside the LPUVB02 in order to control its temperature. Internal temperature must remain within its functioning range, otherwise measurements could be affected by higher systematic errors than those asserted in the manual. Exposure to temperature higher than $+60^\circ\text{C}$ can alter the interferential-filters spectral characteristics.

Working Principle

The LPUVB02 radiometer is based on an innovative solid state photodiode, the spectral response of which was adapted to that desired by using special interferential filters. In particular, the used photodiode and filters have exceptional stability characteristics, both for temperature and through time. This allowed manufacturing of an instrument that does not need heating, thus reducing energy consumption.

Particular attention has been given to filter design so as to make the instrument completely blind to wavelengths outside the concerned pass-band. The solar energy within the 302nm...308nm spectral band is only 0.01% of the total energy from the sun reaching Earth's surface. The relevant spectral response curve is shown in Fig. 1A (in linear scale) and Fig. 1B (in logarithmic scale).

The LPUVB02 is provided with a 50mm-external-diameter dome in order to supply a suitable protection of the sensor to the atmospheric agents. Quartz was chosen due to its optimum transmission in the UV range.

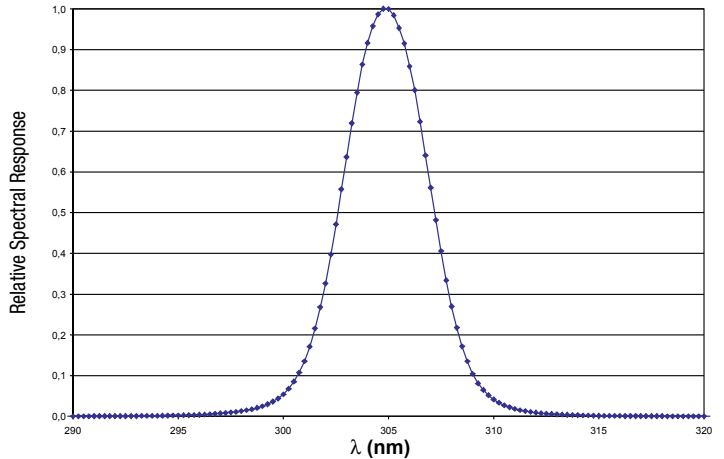

Fig. 1A

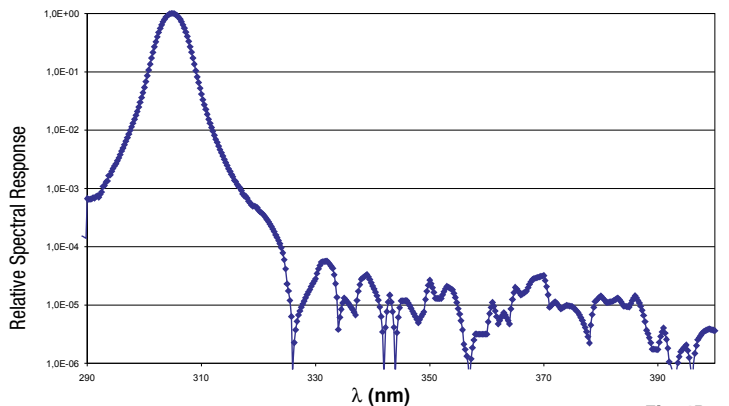

Fig. 1B

The response in accordance with the cosine law has been obtained thanks to the particular shape of the diffuser and of the housing. The departure between a theoretical response and the measured one is shown in the Fig. 2.

The excellent relation between the response of the LPUVB02 and the cosine law allows to use the instrument also when the sun has a very low raising (the UVB diffuse radiation increases as the sun is leaving the zenith, therefore the error on the direct radiation, owing to the imperfect response according to the cosine law, becomes negligible referred to the measurement of the global radiation).

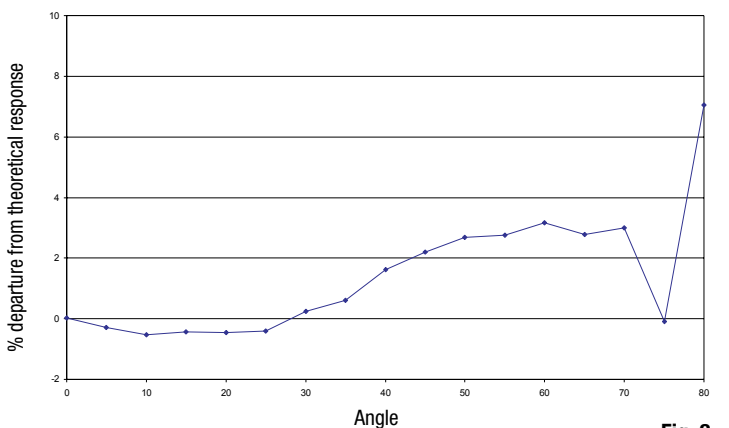

Fig. 2

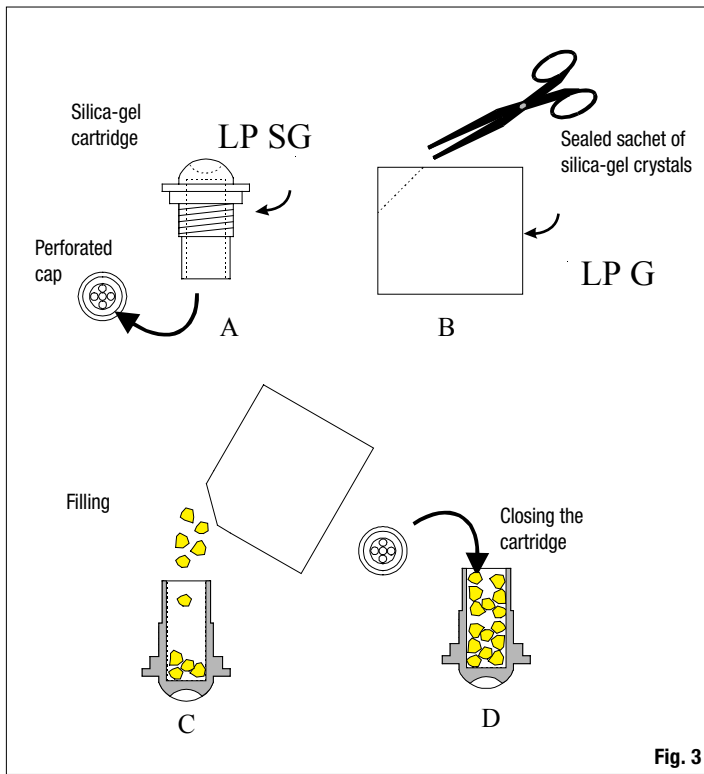

Fig. 3

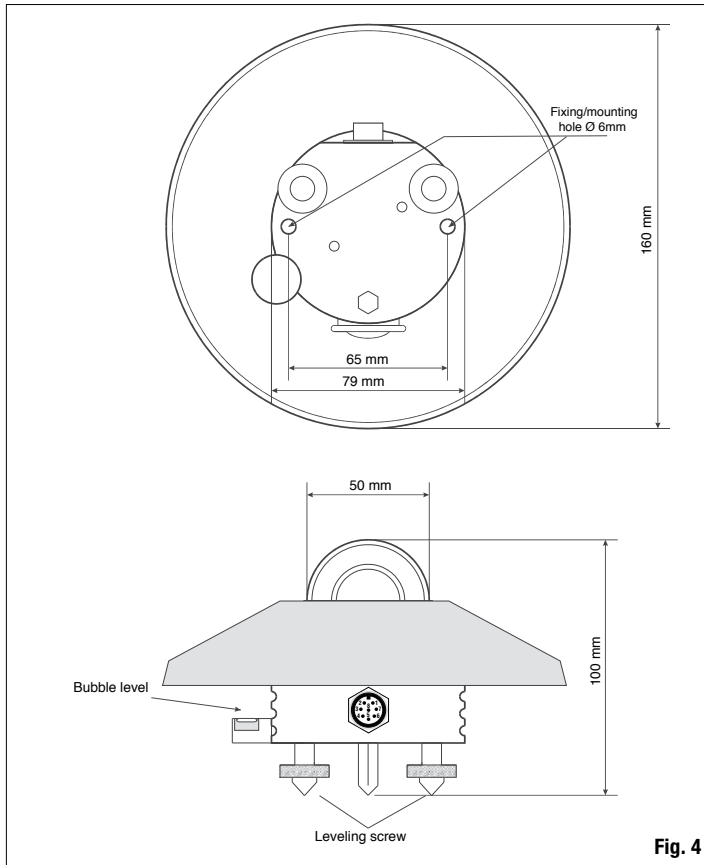

Fig. 4

Installation and Mounting of the Radiometer for the Measurement of the Global Radiation

Before installing the radiometer refill the cartridge containing the silica-gel crystals. Silica gel absorbs humidity in the dome chamber; in case of particular climatic conditions this humidity can cause condensation on the internal side of the dome and then modify the measurement. Do not touch the silica gel crystals with your hands and do not wet them while refilling the cartridge. Carry out the following instructions in an environment as dry as possible:

- 1- loosen the three screws that fix the white shade disk
- 2- unscrew the silica gel cartridge using a coin
- 3- remove the cartridge perforated cap
- 4- open the sachet containing the silica gel (supplied with the radiometer)
- 5- fill the cartridge with the silica-gel crystals
- 6- close the cartridge with its own cap, paying attention that the sealing O-ring be properly positioned and undamaged
- 7- screw the cartridge to the radiometer body using a coin

- 8- check that the cartridge is screwed tightly (if not, the silica-gel life will be reduced)
- 9- position the shade disk and tighten it with the screws
- 10- the radiometer is ready for use

Fig. 3 shows the operations necessary to fill the cartridge with the silica-gel crystals.

- The LPUVB02 has to be mounted in a readily accessible location to be able to provide for a periodic cleaning of the external dome and for the maintenance. Check also that no building, construction, tree or obstruction exceeds horizontal plane where the radiometer lays. If this is not possible, select a site where obstructions do not exceed 5 degrees of elevation, in the path followed by the sun, between earliest sunrise and latest sunset.

- The radiometer has to be located far from any kind of obstruction, which might throw the solar radiation (or its shade) on the radiometer.

- The LPUVB02 radiometer is provided with a spirit level for carrying an accurate horizontal leveling. The adjustment is made by means of two leveling screws that allow to adjust the radiometer inclination. Use the two 6mm-diameter and 65mm-interaxial-distance holes to mount the instrument on a plane. Remove the shade disk to access the holes and reposition it after mounting (see Fig. 4).

- The LPS1 mounting kit (Fig. 5), supplied on demand as an accessory, allows an easy mounting of the radiometer on a mast. The mast maximum diameter shall not exceed 50 mm. The operator shall take care that the mast height does not exceed the radiometer plane to avoid measurement errors caused by any reflection or shadow of the mast itself. To fix the radiometer to the mounting bracket, remove the shade disk loosening the three screws, fix the radiometer and mount the white shade disk again.

- It's suggested to thermally isolate the radiometer from its mounting brackets and to check that the electrical contact with the ground be done properly.

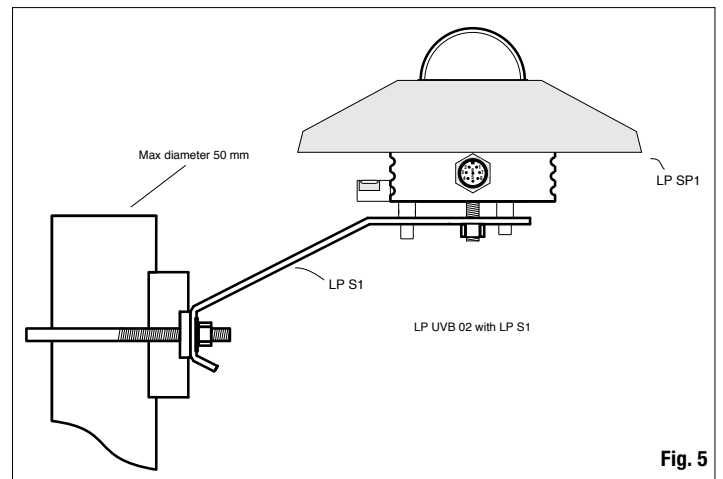

Fig. 5

Electrical Connections and Requirements for Electronic Readout Devices

The connections on the output connector are indicated below:

- Pin8: $V+$, positive supply voltage for LPUVB02 internal electronics.
 $7Vdc < V+ < 30Vdc$
- Pin6: $V_{outTemp+}$, output signal for temperature measurement.
 $0V (-40^{\circ}C) < V_{outTemp+} < 1V (+60^{\circ}C)$
- Pin2: V_{outUV+} , output signal for irradiance measurement in the UVB band.
 $0V < V_{outUV+} < 5Vdc$.
- Pin1: Ground of the two output signals, $V_{outTemp+}$, V_{outUV+}
- Pin7: Housing.
- Pin5: Power supply grounding.

- The LPUVB02 has to be connected either to a voltmeter or to a data acquisition system with input impedance greater than 10k Ω . Typically, the radiometer output signal, when exposed to the sun, does not exceed 1 volt. In order to better exploit the radiometer features, the readout instrument should have 0.1mV resolution.

The connection scheme is shown in figure 6.

The UV-resistant cable (supplied on request) has 6 wires plus the braid (screen); the colour code is shown in fig. 6.

Maintenance

It is important to keep the outer domes clean to grant the best measurement accuracy. Consequently, cleaning the dome more often will give more accurate measurements. Cleaning can be carried out using water and standard papers for lens, or, if not sufficient, using pure ETHYL alcohol. After using alcohol, clean again the dome with water only. Because of the high rise/fall in temperature between day and night, some condensation might appear on the radiometer dome. In this case the performed reading is highly overestimated. To minimize

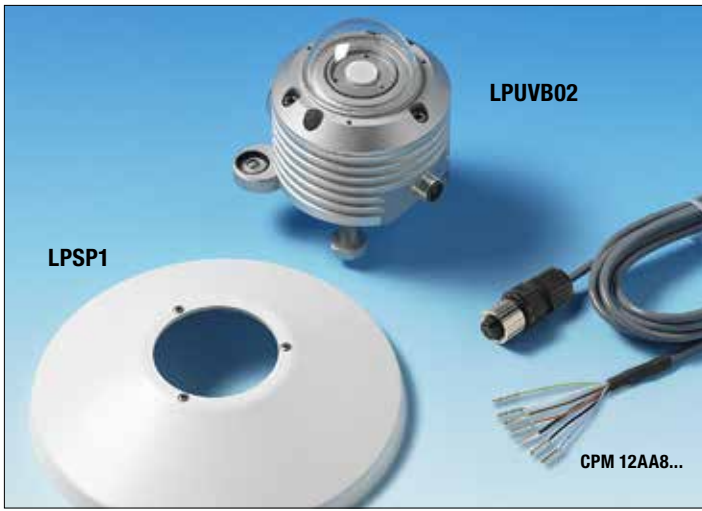

WIRING DIAGRAM LPUVB02

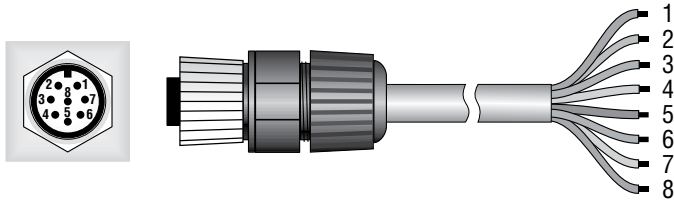

Fixed 8-pole plug M12 Flying 8-pole M12 socket

LPUVB02

Connector	Function	Color
1	Signal GND	Red
2	V out UV (+)	Blue
3	Not connected	
4	Shield	Braid
5	Power GND (-)	Brown
6	Vout Temp. (+)	White
7	Housing	Black
8	Power(+) 7...30Vdc	Green

LPUVB02 CONNECTION DIAGRAMS

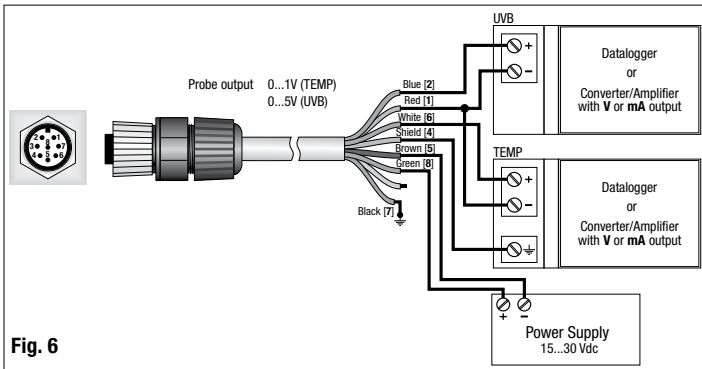

Fig. 6

the condensation growth, the radiometer is provided with a cartridge containing desiccant material: Silica gel. The efficiency of the Silica gel crystals decreases in time with humidity absorption. Silica-gel crystals are active when their colour is **yellow**, and they turn **white** when they loose their power. Read the instructions of paragraph 3 on how to replace them. Silica gel typical duration goes from 2 to 6 months depending on the environment where the radiometer works.

We recommend to calibrate the instrument annually. Calibration can be performed by Delta OHM Metrological Laboratories, or by connecting it to an identical instrument calibrated with reference to a Primary Metrological Institute having a known calibration factor.

Calibration and Measurements

The radiometer **S** sensitivity (or calibration factor) allows to determine the irradiance by measuring a signal in Volts generated by the internal amplification circuit. It is possible that an offset be present on the output signal of some fractions of millivolts (0.3...0.4mV), in which case it is also recommended that the data be acquired at night and subtract the night-measurement offset from the performed measurements. Once the difference of potential (VoutUV+) has been measured at the ends of the resistance, the E_e irradiance is obtained applying the following formula:

$$E_e = [VoutUV+] / S$$

where:

- E_e : is the irradiance expressed in W/m^2 ,
- VoutUV+: is the difference of potential measured by the multimeter and expressed in V,
- S: is the calibration factor in $V/(W/m^2)$, shown on the radiometer label (and mentioned on the calibration report).

In the presence of a possible offset of OF Volts, the previous calculations must be modified as follows:

$$E_e = [(VoutUV+) - OF]/S$$

Similarly, to know the instrument internal temperature once the "VoutTemp+" voltage in volts is known, we get:

$$T = 100 \cdot [VoutTemp+] - 40 \text{ } ^\circ\text{C}$$

Supposing a voltage VoutTemp+=0.532V is read, the previous formula gives the radiometer internal temperature:

$$T = (100 \cdot 0.532) - 40 \text{ } ^\circ\text{C} = 13.2 \text{ } ^\circ\text{C}$$

Radiometers are individually calibrated at factory. Calibration is carried out by measuring the radiometer-produced output signal when hit by a parallel and homogeneous light-beam of 304nm monochromatic light.

Note: currently no international calibration standards for this type of radiometer exist; therefore, the calibration coefficient only makes sense if the procedure followed to obtain it has been specified. Therefore the user has to consider that the same radiometer calibrated with different procedures can have different sensitivity factors, as explained in the article "Source of Error in UV Radiation Measurements", T. C. Larason, C. L. Cromer issued in the "Journal of Research of the National Institute of Standards and Technology" Vol. 106, Num. 4, 2001. (The article is available free of charge on the NIST web site at the following address: <http://www.nist.gov/jers>)

Technical characteristics

UV MEASUREMENT

- Typical sensitivity: $\approx 5V/(W/m^2)$
- Response time: <0.5 sec (95%)
- Min. load impedance: 10 k Ω
- Measurement range: 0...1 W/m^2
- Viewing range: 2π sr
- Spectral range: 305nm Peak
302.5nm...307.5 nm (1/2)
301nm...309 nm (1/10)
297.5nm...311.75nm (1/100)
292.5nm...316.25nm (1/1000)
- Working temperature: -40 $^\circ\text{C}$...+60 $^\circ\text{C}$
- Response according to the cosine law: < 8 % (between 0 $^\circ$ and 80 $^\circ$)
- Long-term instability (1 year): < | ± 3 | %
- Non linearity: < 1 %
- Response according to temperature: < 0.01%/ $^\circ\text{C}$

TEMPERATURE MEASUREMENT

- Measurement range: -40 $^\circ\text{C}$...+60 $^\circ\text{C}$
- Accuracy: $\pm 0.2^\circ\text{C}$
- Min. load impedance: 10 k Ω

POWER SUPPLY

- Vdc+: 7...30 V DC
- Typical consumption: 3 mA
- Dimensions: Fig. 4
- Weight: 0.90 Kg.

ORDERING CODES:

- LPUVB02:** Radiometer for outdoor measurements, complete with LPS1 protection, 2 spare sachets with silica gel crystals, bubble level, 8-pole M12 connector and Calibration Report. **Cable has to be ordered separately.**
- LPS1:** Mounting kit for LPUVB02: bracket for attachment to a mast, including fasteners and leveling screws
- LPS1:** UV resistant plastic shade disk (BASF LURAN S777K).
- LPSG:** Desiccant sachet with silica gel crystals, complete with inner O-ring and cap.
- LPG:** Packet with 5 silica gel spare cartridge.
- CPM12AA 8.2:** 8-pole UV resistant cable L=2 m.
- CPM12AA 8.5:** 8-pole UV resistant cable L=5 m.
- CPM12AA 8.10:** 8-pole UV resistant cable L=10 m.
- LPRING02:** Base with levelling device and adjustable holder for mounting the LPUVB02 in an inclined position.
- LPS6:** Kit for the installation of LPS6.1).The kit includes: 750 mm mast (HD2003.83.1), base fitting (LP S6.04), graduated support plate (LP S6.01), bracket for pyranometers (LP S6.03). On request,HD9007T29.1 bracket for HD9007 or HD32MTT.03.C

HD2021T...



HD2021T... TRANSMITTERS FOR ILLUMINANCE AND IRRADIANCE MEASUREMENTS.

The series of transmitters HD2021T... allow to convert photometric and radiometric quantities, such as illuminance (Lux) and irradiance (W/m^2) in the UVA, UVB, UVC spectral regions and in the 400 ... 1050nm band, into a 0 ... 10Vdc voltage signal. The 0 ... 10 V output voltage (0...1V, 0...5V, 4...20mA available upon request for orders of minimum 5 units) is factory calibrated according to the full scale range specified at the time of order. The wide range of applications

of the HD2012T... transmitters include:

- Control of illuminance (HD2021T...) in offices, manufacturing plants and production areas, commercial sites, theatres, museums, sports facilities, roadway lighting, tunnels and nursery-gardening systems.
- Control of solar radiation in the 400nm...1050nm spectral band (HD2021T1).
- Control of the irradiance emitted by the tanning lamps in the UVA (HD2021T2) and UVB (HD2021T3) spectral regions, as well as control of the efficiency of filters in devices using high pressure lamps.
- Control of the efficiency of the lamps used in sewage treatment plants, where UVC (HD2021T4) band irradiance has to be constantly monitored.

The series of transmitters HD2021T... is suitable to be installed either indoor and outdoor (Protection: IP66). In case of measurements of extremely intense light sources, the transmitter sensitivity can be reduced upon request. The HD2021T... series use filters and photodiodes especially studied to adjust spectral response to a specific region of interest.

INSTALLATION OF THE TRANSMITTERS

Once identified the installation location, provide the electric connections inside the transmitter. Unscrew the four screws on the transmitter cover, lift the cover, the inside of the transmitter is as in Figure 1.

The terminal, easily identifiable, is equipped with three terminals with the following letters:

- GND → is the mass to which the power supply and the output signal are referred
- +Vdc → is the head connected to the positive pole (if a DC power supply is used)
- Vlux (output) → is the output of the system to be connected to the positive pole of a multimeter or to a data acquisition system.

The sample below shows the installation of illuminance HD2021T transmitter for monitoring lamps intensity. For this kind of applications, the HD2021T transmitters are generally installed on ceilings, close to the area where illuminance needs to be monitored (figure 2). By means of a reference Luxmeter (ex. HD2102.1 o HD2102.2 with the probe LP471PHOT) previously placed in the operating area, act on the HD2021T potentiometer up to obtain the reference value desired. The output of the HD2021T is suitable to control several adjustable power supply units at the same time.

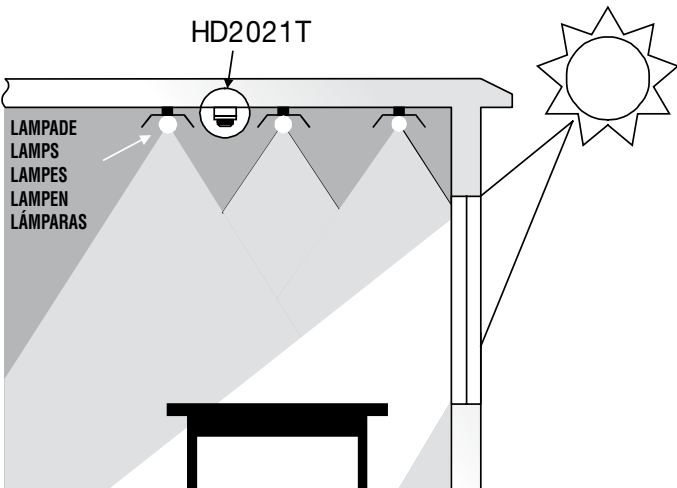

fig. 2

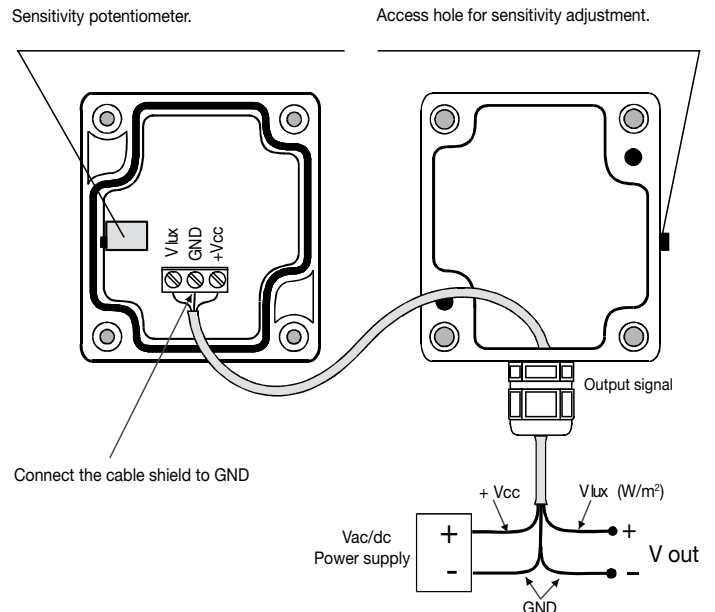
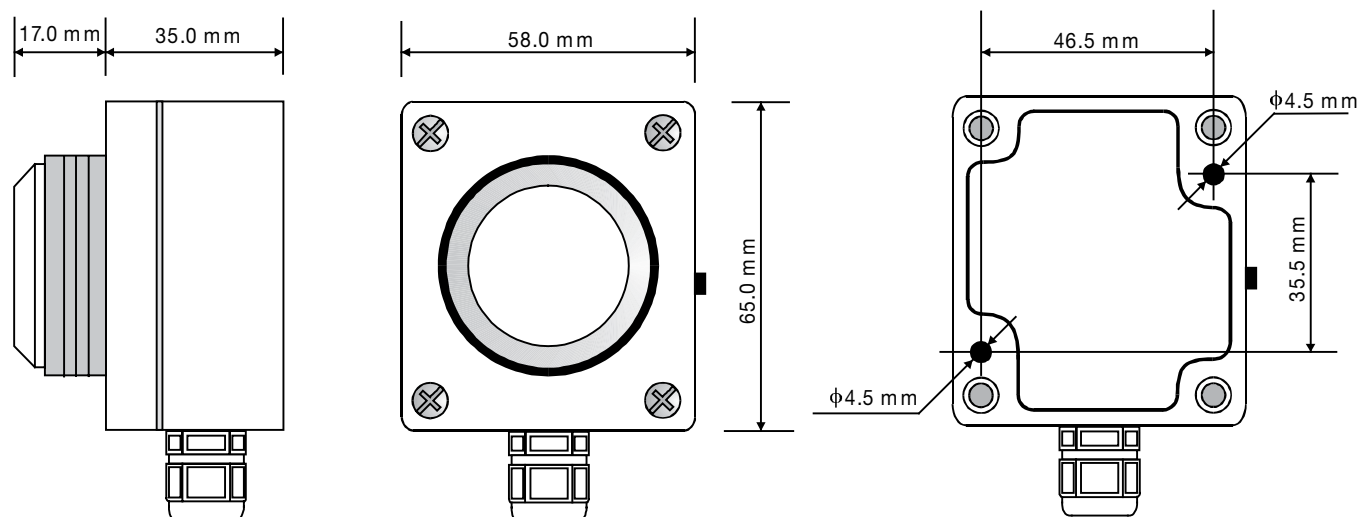

fig. 1

DIMENSIONS:

HD2021T, HD2021T1, HD2021T2, HD2021T3, HD2021T4



TECHNICAL SPECIFICATIONS

	HD2021T	HD2021T1	HD2021T2	HD2021T3	HD2021T4
Sensor	Photodiode Si	Photodiode Si	Photodiode GaP	Photodiode SiC	Photodiode SiC
Spectral range	Curve $V(\lambda)$	450 ... 1050 nm	UVA	UVB	UVC
Measure	Photometric	Radiometric			
Viewing angle	Corrected in accordance with the Cosine law				
Measurement range	see table A - B - C				
	mV/lux	mV/(mW/m ²)	mV/(mW/m ²) peak 360 nm	mV/(mW/m ²) peak 305 nm	mV/(mW/m ²) peak 260 nm
Output signal	0 ... 10 V (0 ... 1 V, 0 ... 5 V minimum order 5 pcs) 4 ... 20mA				
Power supply	16 ... 40 Vdc or 24 Vac, for 0 ... 10 V output 10 ... 40 Vdc or 24 Vac for 0 ... 1 V, 0 ... 5 V output - 10 ... 40 Vdc for 4 ... 20 mA output				
Power consumption	10 mA				
Working temperature	-20 ... +60 °C				
Electrical protection	Protected against polarity inversions				
Maximum dimensions	58 mm x 65 mm x 52 mm				
Degree of protection	IP 66				
Maximum cable length	150 m with output 4...20mA – 10m with the voltage outputs				

ORDERING CODES:

* The full scale value has to be selected in the fields A, B, C

MODEL	A	B	C	X
HD2021T	0.02...2 klux	0.2...20 klux	2...200klux	Other ranges available upon request for at least 5 pcs per order
HD2021T1	0.2...20 W/m ²	2...200 W/m ²	20...2000 W/m ²	
HD2021T2	0.2...20 W/m ²	2...200 W/m ²	20...2000 W/m ²	
HD2021T3	2...200 W/m ²	20...2000 W/m ²		
HD2021T4	2... 200 W/m ²	20...2000 W/m ²		

** For voltage output 0...10V, please indicate: V

For current output 4...20mA, please indicate: A

i.e. HD2021TBA: Transmitter for illuminance range 0,2...20klux, Output 4...20mA



**HD2021T7, HD2021T6
DEBILITATING LUMINANCE PROBE,
LUMINANCE PROBE**

HD2021T7

The HD2021T7 probe allows converting the photometric quantity “equivalent veiling luminance” into a current (4...20 mA) or a voltage (0...10 V) signal according to the version chosen. If the acquisition station is far from the probe (>50m), it is necessary to use the current output version.

The HD2021T7 transmitter has IP67 protection. In order to grant high accuracy, it is important to keep the surface of the outer lens clean. It is possible to wash them by using only water and standard papers for lens. The transmitter full scale can be chosen (when ordering) between two different values: 2000cd/m² or 20000cd/m². For orders of at least 5 pieces, it is possible to calibrate the scale to a value chosen by the customer.

The probe is used for the control of street lighting, in particular, the measurement of equivalent veiling luminance is essential to determine the *threshold luminance* at the entrance of the tunnels (UNI 11095:2011).

The measurement of debilitating luminance (L_v) consists of four components:

$$L_v = L_{seq} + L_{alm} + L_{par} + L_{cru}$$

where,

L_{seq} is the equivalent veiling luminance;

L_{alm} is the atmospheric luminance;

$L_{par} + L_{cru}$ is the luminance of the windshield and the dashboard ($= 0.4 L_{seq}$).

The **equivalent veiling luminance (L_{seq})** is measured according to standard UNI11095:2005 with the probe HD2021T7 as reported in the test report I.N.Ri.M. 08-1199-01. This quantity is measured and defined starting from the subtended angles greater than 1°.

The **atmospheric luminance (L_{alm})** can be calculated from the table E2.2 of UNI 11095 (2011) standard or measured with the HD2021T7.2 probe.

The contribution of the **luminance of the windshield (L_{par})** + the **luminance of the dashboard (L_{cru})** is measured directly by inserting the HD2021T7 probe in a protective case. The dialog interface that separates the probe from the external environment simulates the behaviour of the windshield, so the value read by the probe in the container already includes this contribution.

INSTRUMENT TECHNICAL SPECIFICATIONS

Dimensions

(Length x Width x Height) 147mm x 58 mm x 65mm

Figure 1 Dimensions of the HD2021T7 probe

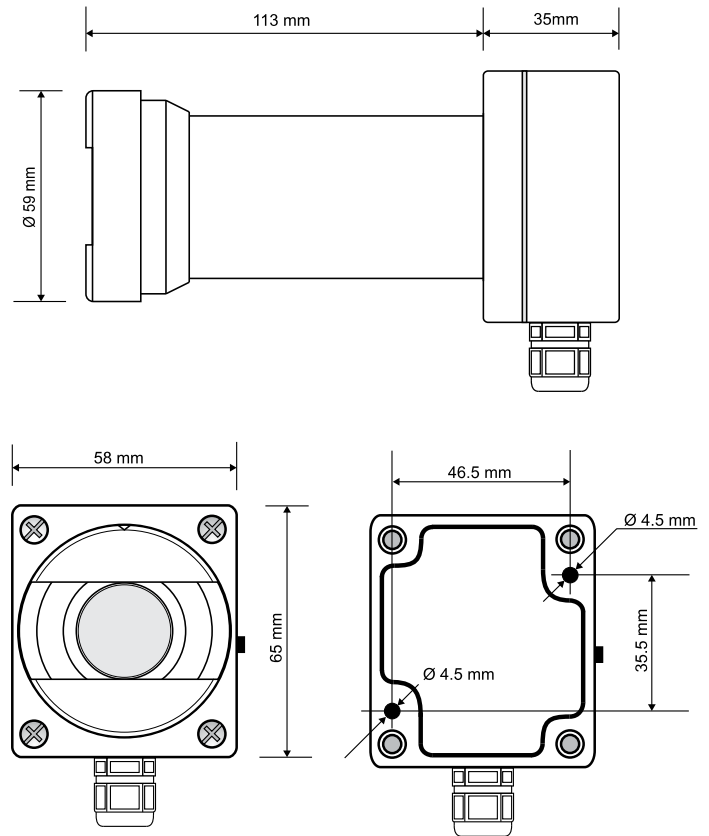

SPECTRAL RESPONSE

The probe uses a silicon photodiode and a set of filters to correct the spectral response curve to make it equal to that of the human eye (photopic response). Figure 2 shows the trend of the relative spectral response according to the wavelength.

$f_1 < 9\%$ according to the standard photopic curve $V(\lambda)$.

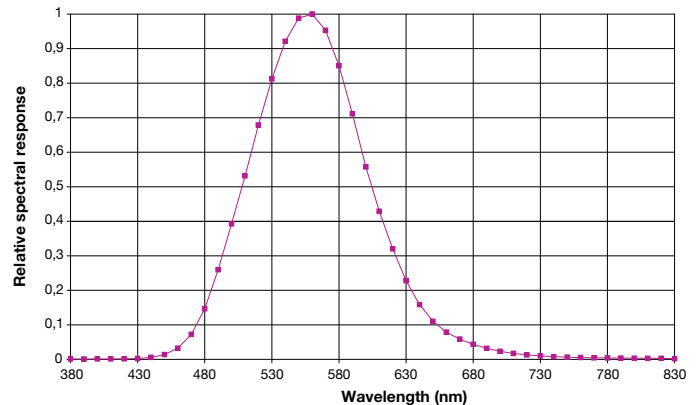

Figure 2. HD2021T7 Relative spectral response

ANGULAR RESPONSE:

The equivalent veiling luminance (L_v) is estimated starting from the following formula:

$$L_v = 10 \sum_{\beta=1^\circ}^{\beta=90^\circ} \frac{L(\beta) \cdot \cos(\beta)}{\beta \cdot (\beta + 1.5)} \cdot \Omega \quad \mathbf{A}$$

where:

- $L(\beta)$ is the luminance of a source of disturbance measured at an angle β ,
- β is the angle between the pointing direction of the object to be watched and the source of interference,
- Ω is the solid angle

Figure 3 shows the sensitivity as a function of the angle of the probe. In the standard CIE88:2004 the equivalent veiling luminance is calculated by considering the contributions up to angles of 28.4°. By using Delta OHM probe HD2021T7 it is possible to evaluate contributions to greater angles (up to 40°).

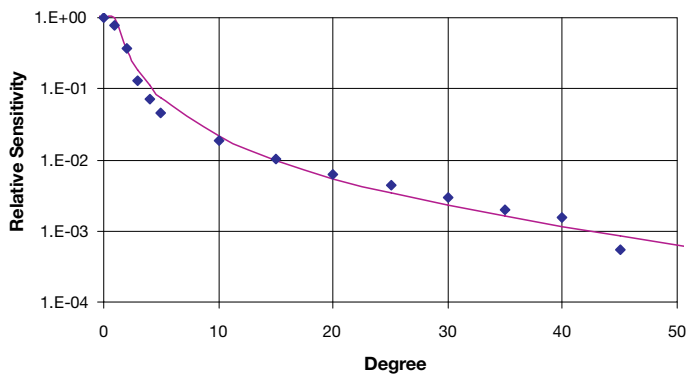

Figure 3. HD2021T7 Relative angular response

WORKING TEMPERATURE

The probe can work in a temperature range from -20° to +60° C. If the probe is placed in watertight containers, take care that there is no fogging or condensation on the window towards which the probe is overlooking. In this case the reading of the equivalent veiling luminance would be altered by systematic errors.

CALIBRATION

The calibration of the probe HD2021T7 is carried out by measuring the luminance on the output port of an integrating sphere with a known luminance. If requested, the uncertainty of the calibration of the probe with fixed full scale is 10% (confidence level of 95%).

TRANSMITTER INSTALLATION

The installation of the probe for the evaluation of the *threshold luminance* at the entrance of tunnels should be performed in compliance with the standard UNI 11095.

In order to connect the transmitter, it is necessary to lift the lid (by unscrewing the four locking screws). For the 4...20mA version, please refer to Figure 5, while the version 0...10 V is referred to Figure 4.

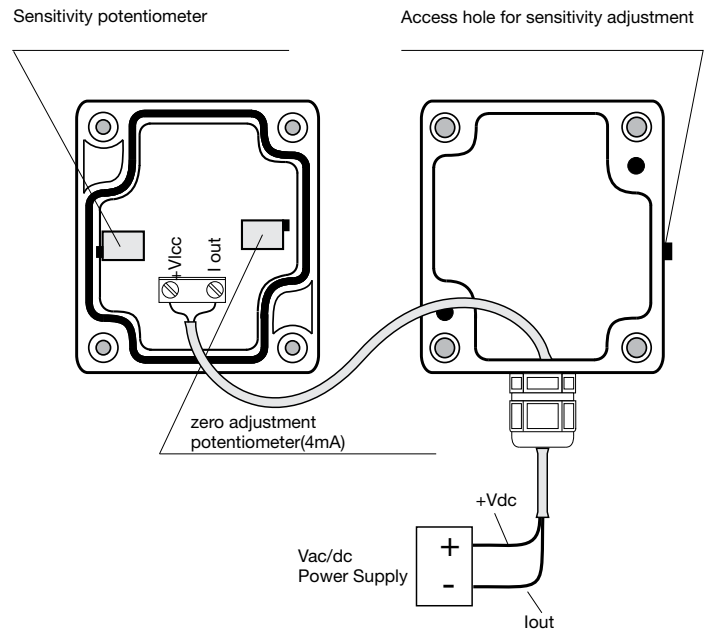
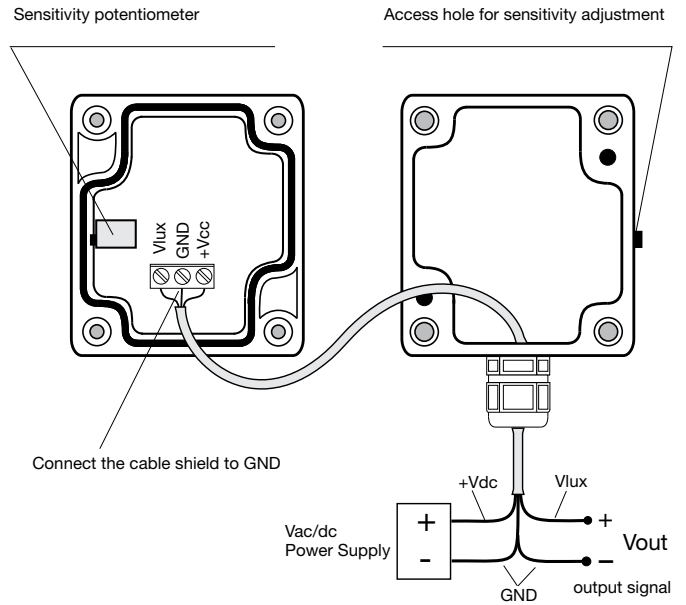

Figure 4. Connection diagram for HD2021T... with voltage output

Figure 5. Connection diagram for HD2021T... with current output

ORDERING CODES:

	Output	Measurement range	Power supply	Spectral response
HD2021T7.AV	0...10 V	0...2000 cd/m ²	16...40 Vac/dc	V(λ)
HD2021T7.BV		0...20 kcd/m ²		
HD2021T7.2.AV		0...2000 cd/m ²		
HD2021T7.AA	4...20 mA	0...2000 cd/m ²		
HD2021T7.BA		0...20 kcd/m ²		
HD2021T7.2.AA		0...2000 cd/m ²		

HD2021T7x.V/A: For a minimum order of 5 pcs, ranges upon request are available.

HD2021T6

The probe HD2021T6 allows converting a photometric quantity Luminance (cd/m^2) into a current (4...20 mA) or voltage (0...10 V) signal according to the version chosen. If the acquisition station is far from the probe ($>50\text{m}$), the current version is required.

The protection degree of the transmitter HD2021T6 is IP67. In order to ensure correct measurements, the outer surface of the lens must be kept clean. If necessary, clean the lens with water and lens cleaning paper.

At the order time, it is possible to choose the transmitter sensitivity among three previously set values: $2 \text{ kcd}/\text{m}^2$, $20 \text{ kcd}/\text{m}^2$ or $200 \text{ kcd}/\text{m}^2$. For orders of quantities over 5 pieces, the full scale can be customized.

The probe is used for road lighting control. In particular, the measurement of luminance at a 20° angle (L_{20}) is necessary to estimate *threshold luminance* at tunnel entrances (CIE standard 88:2004. This standard foresees the measurement of debilitating luminance in future).

Moreover, the probe can be used for calculating vertical illuminance (E_v) as prescribed in the above-mentioned standard.

Finally, the probe can be used for any application where the measurement of luminance is required, for example projector screens, diaphanoscopes etc.

Instrument technical specifications

Dimensions

(Length x Width x Height) 145mm x 58 mm x 65mm

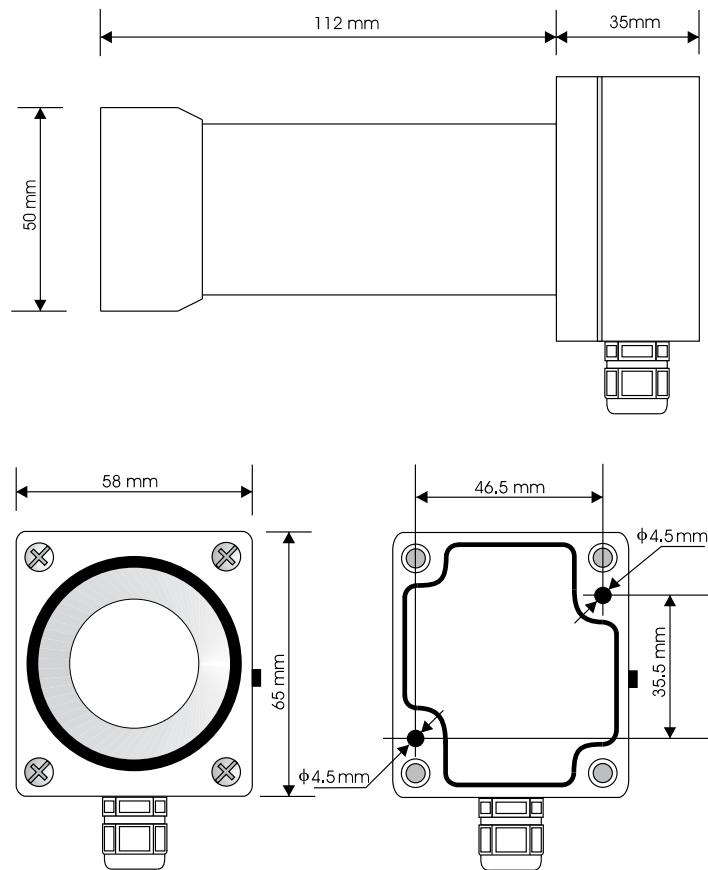

Figure 1. HD2021T6 probe dimensions

Spectral Response

The probe is equipped with a silicon photodiode and a series of filters to correct the spectral response curve and make it equal to that of the human eye (photopic response). Figure 2 shows the trend of the relative spectral response depending on the wavelength.

$f_1 < 9\%$ according to the standard photopic curve $V(\lambda)$.

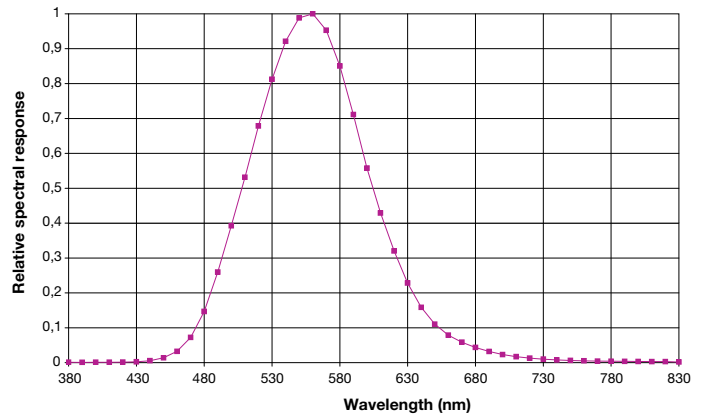

Figure 2. HD2021T6 probe relative spectral response

FIELD OF VIEW

The total field of view of HD2021T6 probe is 20° .

WORKING TEMPERATURE

The probe can work in a temperature range from -20° to $+60^\circ$ C. If the probe is placed in watertight containers, take care that there is no fogging or condensation on the window towards which the probe is overlooking. In this case the reading of the equivalent veiling luminance would be altered by systematic errors.

CALIBRATION

The calibration of the probe HD2021T6 is carried out by measuring the luminance on the output port of an integrating sphere with a known luminance. If requested, the uncertainty of the calibration of the probe with fixed full scale is 5% (confidence level of 95%).

TRANSMITTER INSTALLATION

The installation of the probe for the evaluation of the *threshold luminance* at the entrance to the galleries has to be performed according to standard CIE 88:2004.

In order to connect the transmitter, it is necessary to lift the lid (by unscrewing the four locking screws). For the 4...20mA version refer to Figure 5, while for the version 0...10 V refer to Figure 4 of HD2021T7.

ORDERING CODES:

Model	Output	Measurement range	Power supply	Spectral Response
HD2021T6.AV	0...10 V	0...2000 cd/m^2	16...40 Vac/dc	$V(\lambda)$
HD2021T6.BV		0...20 kcd/m^2		
HD2021T6.CV		0...200 kcd/m^2		
HD2021T6.AA	4...20 mA	0...2000 cd/m^2		
HD2021T6.BA		0...20 kcd/m^2		
HD2021T6.CA		0...200 kcd/m^2		

HD2021T6x.V/A: For a minimum order of 5 pcs, ranges upon request are available.

HD2402



HD2402 INCOHERENT OPTICAL RADIATION MONITORING

The **HD2402** is a portable photo-radiometer data logger for the measurement of **non-coherent optical radiation in compliance with the European Directive 2006/25/EC and the legislative decree n. 81 of April 9th 2008.**

The instrument is equipped with a series of sensors to cover different spectral portions and a small laser suitable to indicate the analyzed source.

The various sensors work in the following spectral ranges:

- Photometric sensor for measuring illuminance (lux meter) in the spectral range 380...780 nm.
- Radiometric sensor for the UV band (220...400 nm) with spectral weighting factor $S(\lambda)$.
- Radiometric sensor for UVA band (315...400 nm).
- Radiometric sensor for the band 400...700 nm (blue) with spectral weighting factor $B(\lambda)$.
- Radiometric sensor for the IR band (700...1300 nm) with spectral weighting factor $R(\lambda)$.
- Thermopile sensor for the measurement of irradiance in the infrared spectral range 400...2800 nm.

The **HD2402** can be power supplied either by the connection to a PC, receiving power supply directly from the USB port of the PC, or by an external power supply with USB output (code **SWD05**). The connection cable **CP24H** is equipped with an M12 connector on the instrument side and a USB type connector for the PC side or to the power supply **SWD05** side.

By using the **software DeltaLog13 from the version 1.0.1.0** and a PC, the **HD2402** can be configured (calendar, date, time, starting time and duration of the logging) as well as performing the download and the analysis of the data stored and the acquisition of data in real time. Once configured, the data logger can be disconnected from the PC and connected to its external power supply for the acquisition and storage of data according to the programmed settings.

Instrument specifications

Instrument

Dimensions

(Length x Width x Height)

69x69x155 mm
74x74x155 mm with protective shell

Weight

500 g

Materials

Aluminium alloy

Protective shell

Rubber

Operating conditions

Working temperature

-5 ... 50°C

Storage temperature

-25 ... 65°C

Working relative humidity
Protection degree

0 ... 85% RH no condensation
IP 64

Power supply

Power adapter (cod. SWD05)

5Vdc/1A

Stored data security

unlimited

Serial interface:

output for connection to the PC by using the USB cable CP24H

Storage capacity:

96,000 recordings, corresponding to approximately 26 hours of continuous data acquisition.

Storage interval:

fixed at 1 second.

Measuring ranges

Measurement of the illuminance in the spectral range 380...780 nm

1.0 ... 399.9 lux
0.010·10⁻³ ... 3.999·10⁻³ lux
0.10·10⁻³ ... 39.99·10⁻³ lux
1.0·10⁻³ ... 399.9·10⁻³ lux

Measurement of the radiation in the spectral range 400...700 nm (blue) with spectral weighting factor $B(\lambda)$

1.0·10⁻³ ... 399.9·10⁻³ W/m²
0.010 ... 3.999 W/m²
0.10 ... 39.99 W/m²
1.0 ... 399.9 W/m²

Measurement of the UV radiation in the spectral range 220...400 nm with spectral weighting factor $S(\lambda)$

0.10·10⁻³ ... 39.99·10⁻³ W/m²
1.0·10⁻³ ... 399.9·10⁻³ W/m²
0.010 ... 3.999 W/m²
0.10 ... 39.99 W/m²

Measurement of infrared radiation in the spectral field 700...1300 nm, with spectral weighting factor $R(\lambda)$

0.010 ... 3.999 W/m²
0.10 ... 39.99 W/m²
1.0 ... 399.9 W/m²
0.010·10³ ... 3.999·10³ W/m²

Measurement of the ultraviolet radiation in the spectral UVA range (315...400 nm)

0.010 ... 3.999 W/m²
0.10 ... 39.99 W/m²
1.0 ... 399.9 W/m²
0.010·10³ ... 3.999·10³ W/m²

Measurement of infrared radiation, spectral range 400...2800 nm

0.010·10³ ... 3.999·10³ W/m²

ORDERING CODES:

HD2402: Multi-sensor instrument, data logger, for measuring noncoherent optical radiation. Equipped with: **DeltaLog13 software** downloadable from Delta OHM website, to download, monitor and process the data on a personal computer, hardware key **CH20-ROA** to enable the software, **CP24H connection cable**, **SWD05 external power supply**, **VTRAP20 tripod**, manual, carrying case.

Accessories:

CH20-ROA: Hardware key for PC with Windows® operating systems. Inserted into a USB port enables the use of PC software DeltaLog13 with the instrument HD2402.

CP24H: Connection cable to a PC or to the external power supply. M12 connector on the instrument side and USB type A- connector on the PC / Power Supply side.

SWD05: Stabilized external power supply 100...240Vac/5Vdc-1A. Output with USB connector type A.

VTRAP20: Tripod to fix the instrument, maximum height 270 mm.



HD30.1



**HD30.1
SPECTRORADIOMETER DATA LOGGER**

The HD30.1 is an instrument made by Delta Ohm for the spectral analysis of light in the visible range and ultraviolet.

The instrument has been designed by combining the maximum flexibility of use, cost reduction and ease of use.

It consists of two elements connected together by a cable: the data logger-indicator HD30.1 and the measurement sensors HD30.S1 (spectral range between 380nm-780nm) and HD30.S2 (spectral range between 220nm-400nm).

The datalogger-indicator HD30.1, based on the **Linux operating system**, makes processing and data management (fig. 1). It has a large touch screen color display, which allows for an easy implementation of the measures, as well as their display and storage (fig. 2). The spectra and the derived parameters can be saved both in the internal memory (150MB) and in the external memory (micro-SD card or USB key). The export format is compatible with the most common programs for the analysis and processing of data. In addition to the data backup, the software allows to save images of the graphs.

The main quantities of photo-radiometric interest are calculated from the HD30.1 by the supplied software.

The analyzed spectral range varies depending on the sensor used to measure:
Visible spectral region (380nm-780nm) by means of the sensor HD30.S1,
Ultraviolet spectral region (220nm-400nm) by means of the sensor HD30.S2.
The measuring sensors are interchangeable and calibrated (the calibration file is stored within each probe).

The sensor HD30.S1 analyzes the visible spectral range (380nm-780nm) and calculates the following photo-colorimetric quantities:

Illuminance [lux], Correlated Color Temperature CCT [K], Trichromatic Coordi-



Input probe HD30.S1- HD30.S2 ON/OFF



nates [x,y] (CIE 1931) or [u',v'](CIE1978), **CRI** (color rendering index, R1...R14, Ra), **PAR** [$\mu\text{mol}/\text{m}^2/\text{s}$].

Fig. 1

The sensor HD30.S2 analyzes the ultraviolet spectral band (220 nm-400 nm) and calculates the following radiometric quantities:

UVA irradiance (W / m^2), **UVB irradiance** (W / m^2) and **UVC irradiation** (W / m^2)

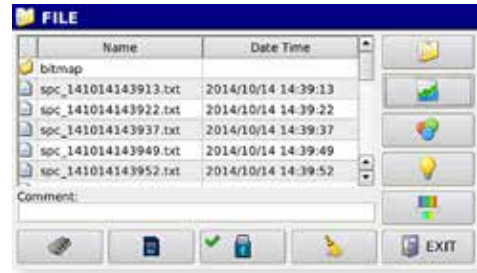
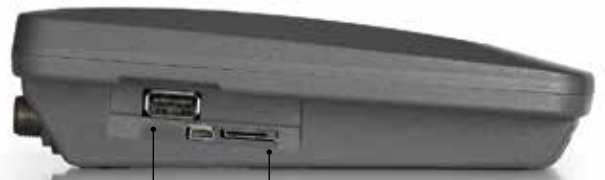

Fig. 2

Both sensors have an optical input equipped with a new generation diffuser that optimizes the response according to the cosine law and does not introduce any spectral deformation.

The data relating to the calibration of each probe are stored in the permanent memory and are read by the indicator.

The system works with internal batteries (rechargeable, 3.7V, 6.6Ah) or connected to the external power supply (SWD06), which has the dual function of powering the unit and charging the battery.



USB MicroSD Card



MiniUSB Ethernet Battery charger power supply

The battery life while the instrument is working is approximately 10 hours, which may increase in particular conditions of use.

APPLICATIONS

Data logger-indicator HD30.1 with the probe HD30.S1 (visible):

In recent years in the lighting field, we are witnessing the advent of LED lighting. The advantages from the point of view of energy compared to conventional systems is not in doubt, even if the performance in terms of color rendering (CRI) are not uniform between different production batches and may vary from manufacturer to manufacturer. With traditional light meters you can just check the level of illuminance [lux] but not the quality of the illumination produced.

Therefore it is necessary to accurately control the colorimetric characteristics of the sources installed in order to evaluate not only the quantity but also the quality.

In the industrial environment, a high color rendering reduces the fatigue of visual field and, in cosmetics, a high color rendering is needed to enhance the quality of the exhibits.

Even more important is the control of the spectrum of the sources installed in the museum environment where the quality of lighting has the dual task of ensuring the optimum viewing of the exhibits (high CRI) and a low emission of blue-violet light that may degrade the materials of the exhibits.

Some neonatal therapies are based on lamps that emit blue light, the appropriate level of radiation can be measured by using the HD30.1. In this case, the light emitted

out of the useful spectral band not only decreases the effectiveness of the therapy but can be harmful.

Data logger-indicator HD30.1 with the probe HD30.S2 (ultraviolet):

The ultraviolet light is used in the most various industrial and civil sectors. Quite often it is not enough to know the total emission of the source, but it is crucial to know how this light is distributed in the spectrum. This is because many processes (sterilization, polymerization and others) are very sensitive to the wavelength of the incident light and not only to its intensity.

In the medical field, some diseases of the skin are treated with the use of UV lamps

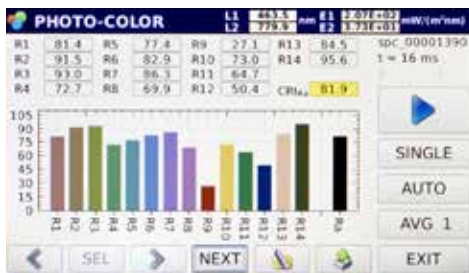
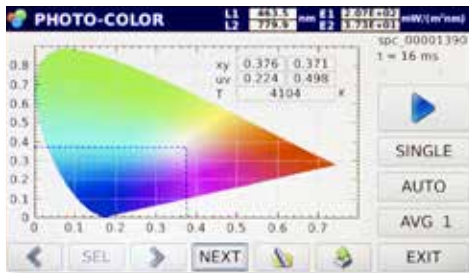
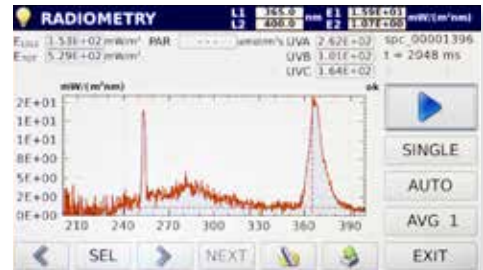
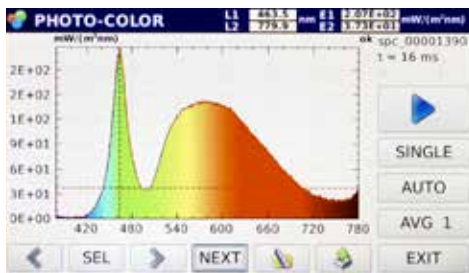
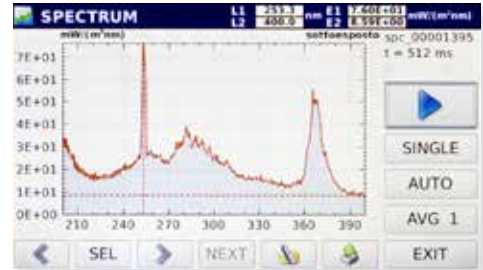
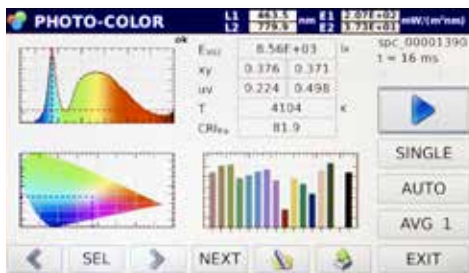

Sensor HD30.S1, Sensor HD30.S2

(UVB), also in this case not only the intensity of light that reaches the skin is important but also its wavelength.

Specifications

MODELLO	HD30.1 + HD30.S1	HD30.1 + HD30.S2
Sensor	CCD linear (2048 elements)	CCD linear (2048 elements)
Spectral Field	380 nm – 780 nm	220 nm – 400 nm
Type of spectrometer	Based on diffraction grating in transmission	
Numerical Aperture	0.16	
Inlet Slit	125µm	70µm
Band-pass	4.5nm	2.5 nm
Wavelength accuracy	0.3 nm	
Reproducibility of the wavelength	0.1 nm	
Averaging Time	From 1ms to 4 s	
Averaging Mode	Automatic/manual	
Diffused Light	<0.03%	
Measuring Mode	Spectral Irradiance, Irradiance, Illuminance [lux], PAR , Correlated Colour Temperature, Trichromatic coordinates CIE 1931 (x,y) & CIE 1976 (u',v'),CRI, Spectral Transmittance	Spectral Irradiance, UVA Irradiance, UVB Irradiance, UVC Irradiance, Spectral Transmittance
Type of Measure	Single , single acquisition with data backup - Continue , continuous acquisition with data backup Monitor , acquisition continues without saving data - Logging , acquisition at time intervals (from 3min to 60min) with data backup	
Optical input dimensions (opaline quartz diffuser)	Φ 11.8 mm	
Cosine correction	By means of opaline quartz diffuser (3mm)	By means of opaline quartz diffuser (2mm)
Calibration	Halogen Standard Lamp	Deuterium Standard Lamp
Working field	Illuminance 5-70000 lux	
Uncertainty	Spectral Irradiance ± 5% Illuminance ± 4% PAR ± 4% CCT ± 45K x,y ± 0.002 CRI ± 1.5	Spectral Irradiance ± 15% UVA Irradiance ± 6% UVB Irradiance ± 8% UVC Irradiance ± 10%
Operating System	Linux	
Display	4.3" touch screen (480x272 pixel)	
Data Storage	Internal (150 MB), micro SD card, USB key (not supplied)	
PC connection	via Ethernet cable, via mini USB connector.	
Power Supply	Rechargeable 6600 mA/h battery Li-po, 3.7V or external power supply SWD06 (6Vdc)	
Exported data format	Compatible with the best known management software /data analysis	
Dimensions/weight of the indicator HD30.1	135x 156 x H 42 mm 440 g	
Dimensions/weight of the probe	75x150x H74, cable length 1.5m 370 g	
Working temperature	0°C-40°C	

Upgrade	automatic via internet
---------	------------------------

ORDERING CODES:

HD30.1: Datalogger-indicator with 4.3" color touch-screen display, 4GB micro SD card, 6600 mA/h lithium-polymer (Li-po) rechargeable battery, power supply/ battery charger SWD06, carrying case and CD with User's Manual

HD30.S2: probe for measuring the ultraviolet spectral range (220nm-400nm).

HD30.S1: probe for measuring the visibile spectral range (380nm-780nm).

HD30.1K: Kit including HD30.1 Data Logger, HD30.S1 probe and HD30.S2 probe.

ACCESSORIES

SWD06: power supply/battery charger for HD30.1

BAT30: 6600mA, 3.3V replacement battery for HD30.1,

Micro SD: 4GB Micro SD card

VTRAP20: Tripod to be fixed to instrument, max height 270mm

CALIBRATION REPORTS

VCERT-L27: Calibration of spectral irradiance between 380 nm and 800 nm, carried out by measuring the irradiance produced by a reference halogen lamp.

VCERT-L28: Calibration of spectral irradiance between 200 nm and 400 nm, carried out by measuring the irradiance produced by a reference deuterium lamp.





ACCREDIA LAT N° 124 laboratory
photometry/radiometry measurements

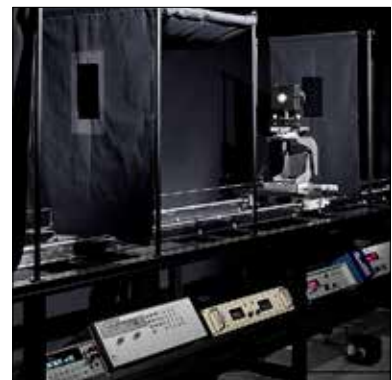
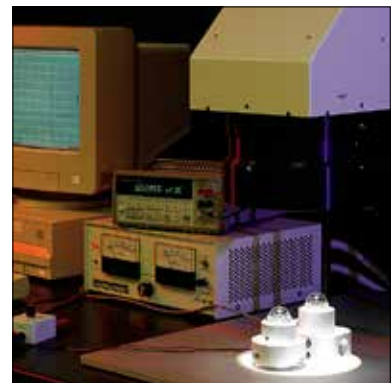
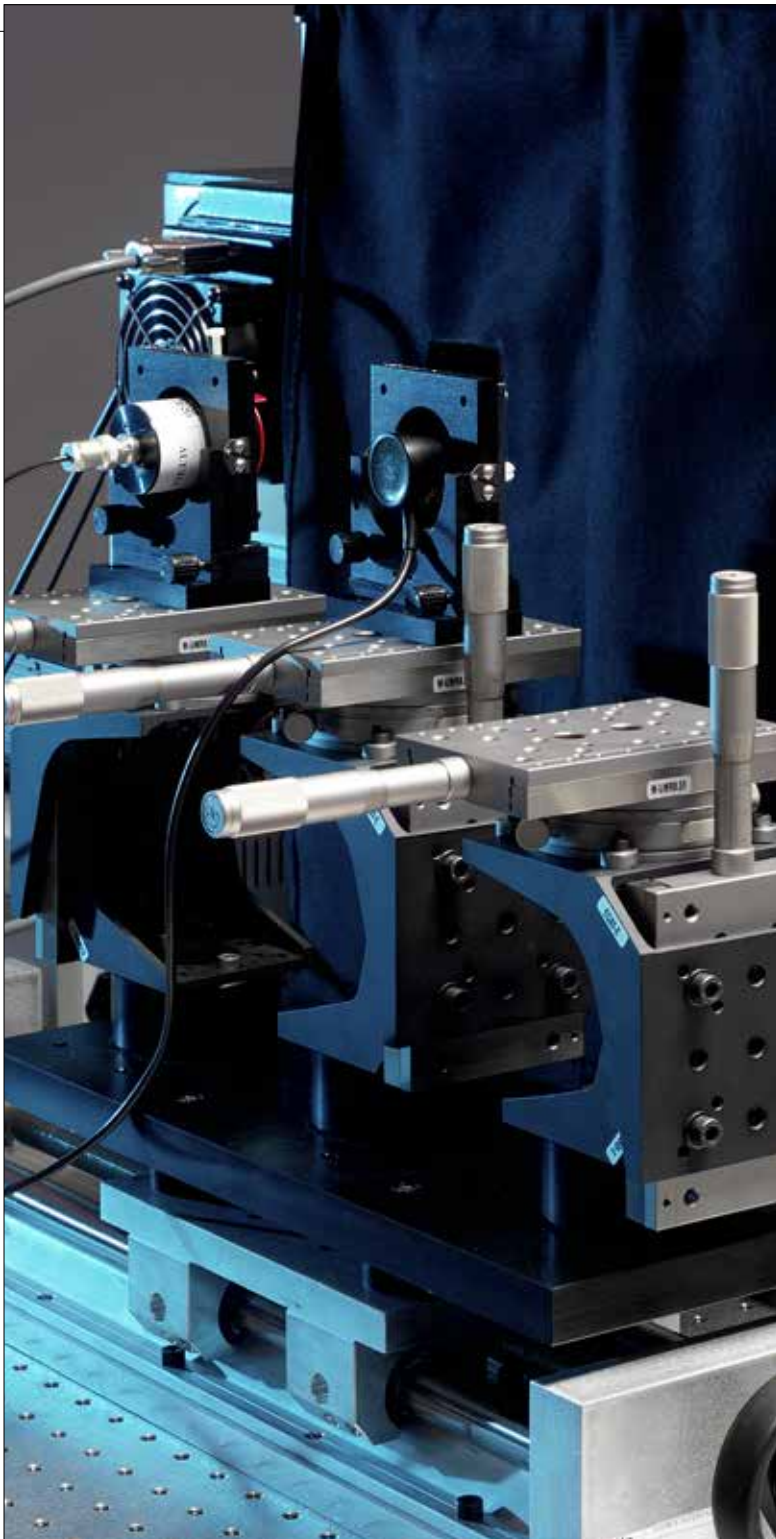

Permanent Laboratory

ACCREDITATION TABLE

Quantity	Instruments to be calibrated	Measuring range	Measuring conditions	Uncertainty
Illuminance	Lux meters	2,5 ÷ 4000 lux		2 %
Luminous Intensity	Incandescence lamps	1 ÷ 3000 cd		2,7 %
Luminance	Luminance meters	1 ÷ 10000 cd m ⁻²		3,2 %
Correlated temperature colour	Incandescence lamps	2200 a 3300 K		50 K
Spectral Radiance	Source	(4·10 ⁻⁵ ÷ 3·10 ⁰) W·m ⁻² ·sr ⁻¹ ·nm ⁻¹ (4·10 ⁻⁵ ÷ 3·10 ⁰) W·m ⁻² ·sr ⁻¹ ·nm ⁻¹	da 300 a 400nm da 400 a 800nm	5 % 4,4 %
Spectral Irradiance	Source UV-A Radiometers UV-B Radiometers UV-C Radiometers	(1·10 ⁻⁵ ÷ 1·10 ⁰) W·m ⁻² ·nm ⁻¹ (1·10 ⁻⁵ ÷ 1·10 ⁰) W·m ⁻² ·nm ⁻¹ (1·10 ⁻⁵ ÷ 1·10 ⁰) W·m ⁻² ·nm ⁻¹ (1·10 ⁻⁵ ÷ 1·10 ⁰) W·m ⁻² ·nm ⁻¹ (1·10 ⁻⁵ ÷ 1·10 ⁰) W·m ⁻² ·nm ⁻¹ (1·10 ⁻⁵ ÷ 1·10 ⁰) W·m ⁻² ·nm ⁻¹ 1 ÷ 50 W·m ⁻² 1,2W/m ² 1,5W/m ²	(200 ÷ 250) nm (250 ÷ 300) nm (300 ÷ 350) nm (350 ÷ 400) nm (400 ÷ 700) nm (700 ÷ 800) nm (365) nm (311) nm (254) nm	10% 7,0% 4,4% 3,8% 3,2% 3,6% 5,0% 6,6% 7,2%
Spectral Sensitivity	Detectors	(1·10 ⁻² ÷ 1·10 ¹) A·W ⁻¹ (1·10 ⁻³ ÷ 1·10 ¹) A·W ⁻¹ (1·10 ⁻⁴ ÷ 1·10 ¹) A·W ⁻¹ (1·10 ⁻⁴ ÷ 1·10 ¹) A·W ⁻¹ (1·10 ⁻⁴ ÷ 1·10 ¹) A·W ⁻¹ (1·10 ⁻⁴ ÷ 1·10 ¹) A·W ⁻¹ (1·10 ⁻⁴ ÷ 1·10 ¹) A·W ⁻¹	(200 ÷ 240) nm (240 ÷ 375) nm (375 ÷ 920) nm (920 ÷ 1000) nm (1000 ÷ 1100) nm (1100 ÷ 1550) nm (1550 ÷ 1650) nm	6,6% 3,7% 1,9% 2,0% 2,2% 2,0% 2,6%
Solar irradiance sensitivity	Pyranometers		Normal irradiance from 450 to 550 W/m ²	2,6%

(*)The uncertainty of measurement is stated as expanded uncertainty corresponding to a confidence level of 95% and is obtained by multiplying the uncertainty by the coverage factor k specified.

Calibration according to ISO 9847:1991 regulation (IIC method)



contact us



Headquarter

GHM Messtechnik GmbH
GHM GROUP CORPORATE
Tenter Weg 2-8
42897 Remscheid | GERMANY
Phone +49 2191 9672-0
info@ghm-group.de
www.ghm-group.de

Centers of Competences

GHM Messtechnik GmbH
GHM GROUP – Greisinger
Hans-Sachs-Straße 26
93128 Regenstauf | GERMANY
Phone +49 9402 9383-0
info@greisinger.de | www.greisinger.de

GHM Messtechnik GmbH
GHM GROUP – Honsberg
Tenter Weg 2-8
42897 Remscheid | GERMANY

GHM Messtechnik GmbH
GHM GROUP – Martens
Kiebitzhörn 18
22885 Barsbüttel | GERMANY

GHM Messtechnik GmbH
GHM GROUP – Imtron
Carl-Benz-Straße 11
88696 Owingen | GERMANY

Delta OHM S.r.l. a socio unico
GHM GROUP – Delta OHM
Via Marconi 5
35030 Caselle di Selvazzano
Padova (PD) | ITALY
Phone +39 049 8977150
info@deltaohm.com
www.deltaohm.com

Valco srl
GHM GROUP – VAL.CO
Via Rovereto 9/11
20014 S. Ilario di Nerviano
Milano (MI) | ITALY
Phone +39 0331 53 59 20
valco@valco.it
www.valco.it

GHM GROUP International

Austria
GHM Messtechnik GmbH
Office Austria
Breitenseer Str. 76/1/36
1140 Vienna | AUSTRIA
Phone +43 660 7335603
a.froestl@ghm-messtechnik.de

Brazil & Latin America
GHM Messtechnik do Brasil Ltda
Av. José de Souza Campos, 1073, cj 06
Campinas, SP
13025 320 | BRAZIL
Phone +55 19 3304 3408
info@grupoghm.com.br

Czech Republic/Slovakia
GHM Greisinger s.r.o.
Ovci hajek 2/2153
158 00 Prague 5
Nove Butovice | CZECH REPUBLIC
Phone +420 251 613828
Fax +420 251 612607
info@greisinger.cz | www.greisinger.cz

Denmark
GHM Maaleteknik ApS
Maarslet Byvej 2
8320 Maarslet | DENMARK
Phone +45 646492-00
Fax +45 646492-01
info@ghm.dk | www.ghm.dk

France
GHM GROUP France SAS
Parc des Pivoilles
9 Rue de Catalogne
69150 Décines-Charpieu (Lyon) | FRANCE
Phone +33 4 72 37 45 30
a.jouanillou@ghm-group.fr

India
GHM Messtechnik India Pvt Ltd.
209 | Udyog Bhavan | Sonowala Road
Gregaon (E) | Mumbai - 400 063
INDIA
Phone +91 22 40236235
info@ghmgroup.in | www.ghmgroup.in

Italy for Greisinger & Delta OHM
GHM GROUP – Delta OHM
Via Marconi 5
35030 Caselle di Selvazzano
Padova (PD) | ITALY
Phone +39 049 8977150
a.casati@ghm-messtechnik.de

Italy for Honsberg, Martens, Valco
GHM GROUP – Valco
Via Rovereto 9/11
20014 S. Ilario di Nerviano
Milano (MI) | ITALY
Phone +39 0331 53 59 20
alessandro.perego@valco.it

Netherlands
GHM Meettechniek BV
Zeeltweg 30
3755 KA Eemnes | NETHERLANDS
Phone +31 35 53805-40
Fax +31 35 53805-41
info@ghm-nl.com | www.ghm-nl.com

South Africa
GHM Messtechnik SA (Pty) Ltd
16 Olivier Street
Verwoerdpark, Alberton 1453
SOUTH AFRICA
Phone +27 74 4590040
j.grobler@ghm-sa.co.za

...and more than
100 qualified distributors!



Visit us at: www.ghm-group.de/en